

SANYO

Colour Television Service Manual

CE21DN4-C

Model CE21DN4-C

Service Ref.No.: CE21DN4-C-01

PRODUCT CODE: 111339616
ORIGINAL VERSION: Chassis No.:EB4-A(MKII)

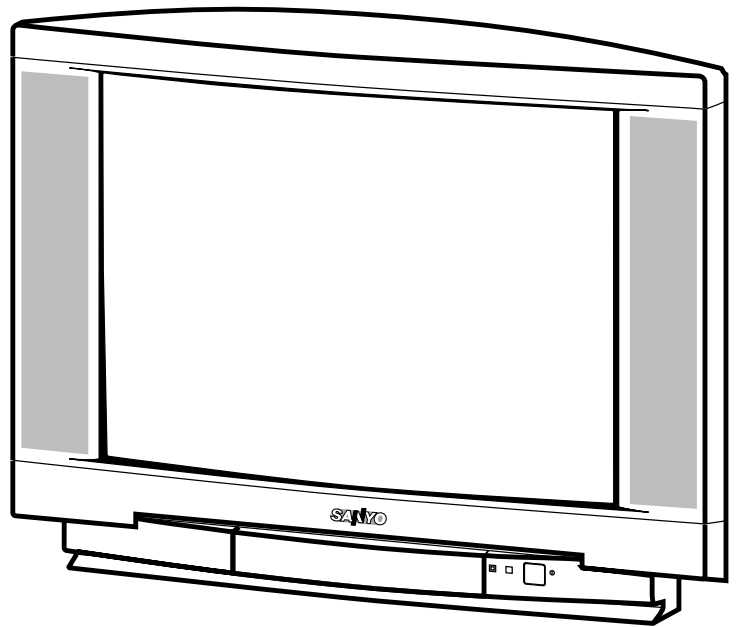

Give complete "SERVICE REF. NO." for parts order or servicing, it is shown on the rating sheet on the cabinet back of the TV set.

Note
This TV receiver will not work properly in foreign countries where the television transmission system and power source differ from the design specifications. Refer to the specifications for the design specifications

Contents

Safety precautions/Specifications	2
Block diagram	3
Circuit description	4-5
Cabinet Disassembly	6
Service control adjustment	7
Circuit alignment	8
Important notice	9
Special Function	10
Cabinet Parts List	11
Electric Parts List	12-21

SAFETY PRECAUTION

- | | |
|--|--|
| <p>1: An isolation transformer should be connected in the power line between the receiver and the AC line when a service is performed on the primary of the converter transformer of the set.</p> <p>2: Comply with all caution and safety-related notes provided on the cabinet back, inside the cabinet, on the chassis or the picture tube.</p> | <p>3: When replacing a chassis in the cabinet, always be certain that all the protective devices are installed properly, such as, control knobs, adjustment covers or shields, barriers, isolation resistor-capacitor networks etc. Before returning any television to the customer, the service technician must be sure that it is completely safe to operate without danger of electrical shock.</p> |
|--|--|

X-RADIATION PRECAUTION

The primary source of X-RADIATION in the television receiver is the picture tube. The picture tube is specially constructed to limit X-RADIATION emissions. For continued X-RADIATION protection, the replacement tube must be the same type as the original including suffix letter. Excessive high voltage may produce potentially hazardous X-RADIATION. To avoid such hazards, the high voltage must be maintained within specified limit. Refer to this service manual, high voltage adjustment for specific high voltage limit. If high voltage exceeds specified limits, take necessary corrective action. Carefully follow the instructions for +B1 volt power supply adjustment, and high voltage adjustment to maintain the high voltage within the specified limits.

PRODUCT SAFETY NOTICE

Product safety should be considered when a component replacement is made in any area of a receiver. Components indicated by mark Δ in the parts list and the schematic diagram designate components in which safety can be of special significance. It is particularly recommended that only parts designated on the parts list in this manual be used for component replacement designated by mark Δ . No deviations from resistance wattage or voltage ratings may be made for replacement items designated by mark Δ .

PRODUCT SPECIFICATIONS

Power source	AC 220~240V, 50Hz
Television system	System B/G, D/K
Colour system	PAL/NTSC 4.43/SECAM
Receiving channel	VHF: E2-E12, R1~R12 CATV: X, Y, Z, S1-S41 UHF: #21~69
Aerial input impedance	75 ohm
AV terminal	
21 Pin socket	AV1: CENELEC standard (with RGB/S-inputs) AV2: CENELEC standard AV2: RCA Terminal, video and audio (L/R) input
Sound output(Music)	9 watts x 2
Picture tube	51cm diagonal, 90 degree
(Visible picture diagonal)	55cm
Dimensions (WxHxD)	612 x 476 x 486mm
Weight	21 Kg

BLOCK DIAGRAM

This is a diagram for all models and therefore differs slightly from the actual block diagram.

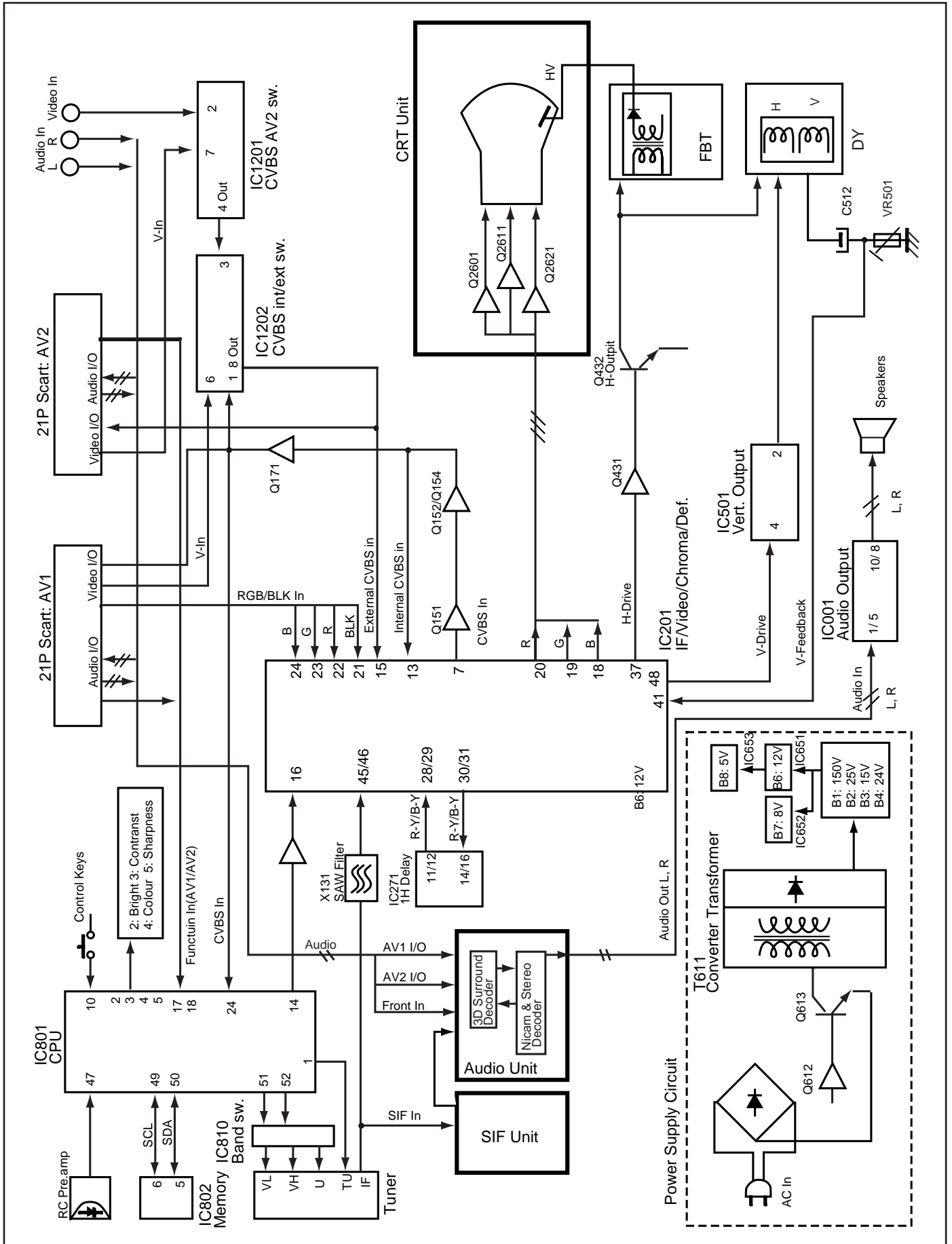

CIRCUIT DESCRIPTION

1. POWER SUPPLY

The power supply circuit of the EB4-A chassis is composed of a rectifier smoothing circuit, an oscillation circuit, a control circuit and an output rectifier circuit. The AC input voltage is full-wave rectified by the rectifier smoothing circuit, and an unstable DC voltage is generated at both terminals of the smoothing capacitor C607. This voltage is input to the oscillation circuit. The oscillation circuit is provided with a blocking oscillator circuit that switches the switching transistor Q613 ON and OFF, and an oscillation frequency and a duty square wave pulse are generated in the input windings according to operation of the control circuit. A square-wave pulse whose size is dependent on the turn ratio of the input and output windings is obtained in the output winding. This is rectified in the output rectifier circuit, and the desired DC voltage is obtained.

2. IF & DEFLECTION (TDA8361)

The IF output signal from the tuner passes through the SAW filter, and it is input to pin45 and pin46 of IC201. The signal input to the IC passes through the IF amplifier, video detection and video amplifier circuits and is output from pin7 as a composite video signal. And after this signal is converted to impedance at Q151, supplies to the video and chroma amplifier stages. The sync.-separation circuit separates the video signals applied to pin13(internal video signal) or pin15(external video signal) to vertical- and horizontal-sync. signals respectively. The horizontal oscillator requires no external components and is fully integrated. The oscillator is always running when the start-pin36 is supplied with 8V. Horizontal drive signal is output from pin37. VR361 is for adjustment of the horizontal centring. The separated vertical-sync. signal from sync. separation circuit passes through the vertical-separation circuit, and applied to trigger divider circuit. The horizontal oscillation pulse and input vertical sync. pulse are monitored by the trigger divider circuit, and switching 50Hz and 60Hz system, the vertical amplitude automatically adjusted for 50Hz and 60Hz. The output signal from the trigger divider is triggered vertical oscillation circuit consisting of C351, R352 and pin42, and vertical drive pulse is output from pin43. VR501 is for changing the amount of AC feedback applied to pin41 and for adjustment of the vertical amplitude.

3. VIDEO CHROMA & R.G.B. (TDA8361)

The composite video signal output from the pin7 of IC101 passes through Q151-Q154, and it is supplied to pin13. The external video signal output from SCART is supplied to pin15. The video signal input to pin13 or pin15 is separated to luminance (Y) signal and chroma signal in IC201. These pins are used in common with H/V-sync. separation input. The peaking of Y signal is adjusted by DC voltage of pin14. ("SHARPNESS" control) The chroma signal is divided into R-Y and B-Y

chroma signals, demodulated in IC201, and output from pin30 (R-Y) and pin31 (B-Y). These chroma signals pass through the 1H delay line circuit (IC271), and they are input to pin29 (R-Y) and pin28 (B-Y). These R-Y/B-Y signals pass through RGB matrix circuit and RGB selector circuit of IC101. The internal RGB signals are generated in RGB matrix circuit and the RGB selector, consisting linear amplifiers, clamps and selects either the internal RGB signals or the external RGB signals input from pin22(R), pin23(G), pin24(B). Selection is controlled by the voltage at the RGB switch control (pin21) and mixed RGB modes are possible since RGB switching is fast. The RGB switch also functions as a fast blanking pin by blanking the RGB output stages; here internal and external RGB signals are overruled. The colour gain is controlled by DC voltage of pin26. ("COLOUR" control) The contrast control voltage present at pin25, and the brightness control voltage present at pin17 controls DC level of RGB signals. The RGB signals are finally buffered before being available at the RGB output pins [pin20 (R), pin19 (G), pin18 (R)].

4. AUDIO OUTPUT(TDA7263M)

The audio signals output from the audio unit are input to pin1(L) and 5(R) of IC171 and passes through the pre-amplifier circuit and drive circuit, after which it is input to the audio amplifier. The audio amplifier is an SEPP (single-ended, push-pull) OTL type and output to pin8(R) and 10(L) to directly drive the speakers.

5. VERTICAL OUTPUT (LA7832/LA7832)

An IC (LA7832/LA7833) is used for the vertical output circuit in this chassis. The vertical drive pulse from pin43 of IC201 is input to pin4 of IC501. This pulse drives IC501, and vertical scanning is performed. In the first half of scanning a deflecting current is output from pin2 and passes through the following path: $V_{cc}(B4) \rightarrow D501 \rightarrow \text{pin3} \rightarrow \text{pin2} \rightarrow \text{DY} \rightarrow C512 \rightarrow \text{VR501/R509}$. An electric charge is then stored in C512. In the last half of scanning the current path is $C512 \rightarrow \text{DY} \rightarrow \text{pin2} \rightarrow \text{pin1} \rightarrow \text{VR501/R509} \rightarrow C512$. In this way, an amplifying sawtooth waveform current flows directly to DY to perform electron beam deflection. Next, in the first half of the banking period the vertical drive pulse suddenly becomes OFF, and in order to reduce the current flowing to DY, the current path becomes as follows by the inductance of DY: $\text{DY} \rightarrow \text{pin2} \rightarrow \text{pin1} \rightarrow \text{VR501/R509} \rightarrow C512 \rightarrow \text{DY}$. Also, when the charge of DY has dissipated, the current path becomes $V_{cc}24V \rightarrow \text{pin6} \rightarrow \text{pin7} \rightarrow C502 \rightarrow \text{pin3} \rightarrow \text{pin2} \rightarrow \text{DY} \rightarrow C512 \rightarrow \text{VR501/R509}$, and when the prescribed current value is reached, the vertical drive pulse becomes ON. This completes one cycle.

6. HORIZONTAL OUTPUT

A horizontal oscillation signal is output from pin37 of IC201 and switches the drive transistor Q431. This switching signal is current amplified by the drive transformer T431 and drives the output transistor Q432. When Q432 becomes ON, an amplifying current flows directly to DY through C441 → DY → Q432 → GND, and deflection is performed in the last half of the scanning period. Next, when Q432 becomes OFF, the charge that had been stored in DY up to that point releases a resonance current to the resonant capacitors C421/C423 and charges them. The current stored in C421/C423 is then flowed back to DY, and an opposite charge is then stored in DY. This opposite charge then switches the dumper diode in Q432 ON, the resonance state is completed, and an amplifying current is then flowed again directly to DY through the dumper diode. By this means, deflection in the first half of the scanning period is performed, and when Q432 becomes ON at the end of the first half of the scanning period, deflection during the last half is begun, thus completing one cycle.

In the PCC circuit consisting of Q461 and Q462, the parabola signal supplied from the vertical circuit is added at the horizontal output stage and pincushion compensation is performed by varying the DC voltage bias. Further, the ABL voltage is feedback to the base of Q462 to compensate for width variations due to variations in the beam current.

7. CPU <System and Teletext Control>

Pin description

Pin1: Tuning voltage output
Pin2: Brightness control output (6-bit DAC)
Pin3: Contrast control output (6-bit DAC)
Pin4: Colour control output (6-bit DAC)
Pin5: Sharpness control output(6-bit DAC)
Pin6: Not used (GND)
Pin7: Not used (GND)
Pin8: Power ON/OFF output (H:ON)
Pin9: AFT signal input
Pin10: Option SW1 & Keyboard scan input (DC)
Pin11: Option SW2
Pin12: 50/60Hz switch input (50Hz: Hi)
Pin13: GND
Pin14: TV/AV switch output (TV: Hi)
Pin15: S-VHS switch output (S-VHS: Hi)
Pin16: Option SW3 (2AV: Hi)
Pin17: Function signal input for SCART1
Pin18: Function signal input for SCART2
Pin19: Power LED drive output1
Pin20: Option SW4 & Power LED drive output2
Pin21: Ignore output
Pin22: GND
Pin23: CVBS input0 (Internal)
Pin24: CVBS input1 (Internal/External)
Pin25: Black

Pin26: IREF
Pin27: Odd/Even output
Pin28: GND
Pin29: -
Pin30: V-deflection stop output
Pin31: RGB REF
Pin32: Blue output for OSD
Pin33: Green output for OSD
Pin34: Red output for OSD
Pin35: Blanking output for OSD
Pin36: H-sync. input (Horizontal pulse for OSD)
Pin37: V-sync. input (Vertical pulse for OSD)
Pin38~39: Supply (+5V)
Pin40: OSC GND
Pin41: Oscillator input for CPU
Pin42: Oscillator output for CPU
Pin43: Reset input
Pin44: Supply (+5V)
Pin45: Protect signal input (L:Power circuit defects)
Pin46: Ident. signal input
Pin47: R/C signal input
Pin48: Mute output in no picture
Pin49: I²C bus SCL (Serial clock)
Pin50: I²C bus SDA (Serial date)
Pin51: Option SW5 & Band select output1
Pin52: Band select output2

CABINET DISASSEMBLY

CABINET BACK DISASSEMBLY

1. Remove 7 screws(A).
2. Pull out the cabinet back.

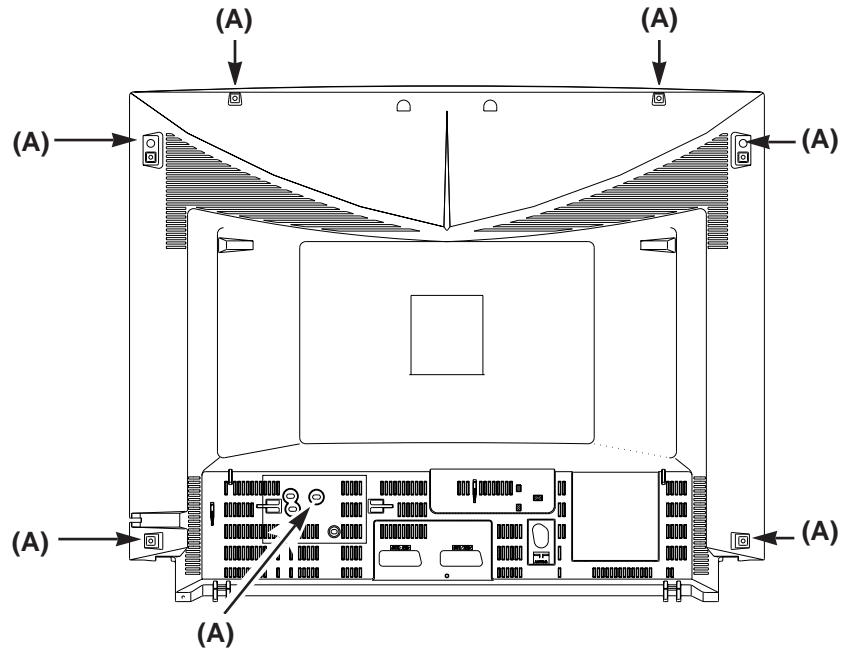

SERVICE CONTROL ADJUSTMENT

B1 POWER SUPPLY ADJUSTMENT

1. Set VR641 to be mechanical centre before pressing the main switch.
2. Tune the receiver to PAL circular pattern.
3. Set brightness and contrast controls to normal.
4. Connect digital V-meter to test point "TP-B".
5. By using VR641, adjust voltage to 130 ± 0.5 V.

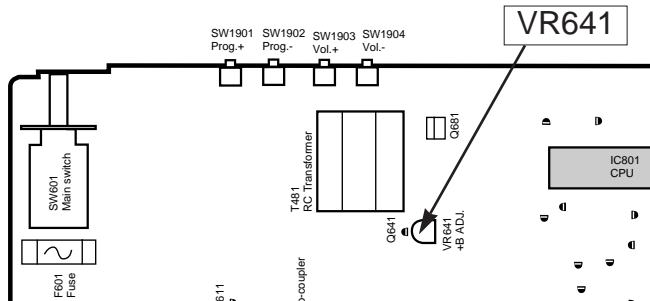

AFT ADJUSTMENT

1. Tune the receiver to the clearest station.
2. By using T141, adjust AFT to obtain the best picture.

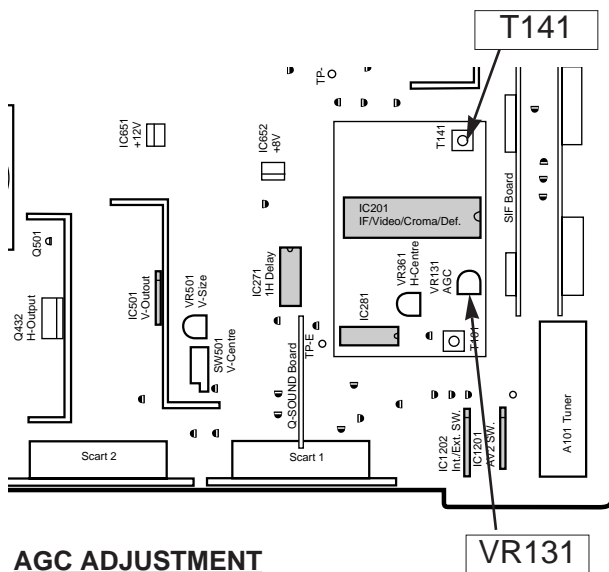

AGC ADJUSTMENT

NOTE: Do not attempt this adjustment with weak signal.

1. Tune the receiver to the clearest station.
2. Set AGC VR (VR131) in direction which causes snow noise to appear, then in the opposite direction until snow noise just disappears.

GREY SCALE ADJUSTMENT

[SCREEN VR ADJUSTMENT]

1. Tune the receiver to the white pattern.
2. Set brightness and contrast controls to normal.
3. Set VR602 and VR612 to be mechanical centre.
4. Turn VR601, VR611 and VR621 fully counter-clockwise.
5. Set mode to one horizontal scanning line, how to set refer to "service mode"

6. Set screen VR for one colour to be just visible.

[BIAS VR ADJUSTMENT]

7. By using VR601, VR611 or VR621, adjust line to be white.
8. Set screen mode OFF, how to set refer to "service mode"

[DRIVE VR ADJUSTMENT]

9. By using VR602 and VR612, adjust white balance.

HIGH VOLTAGE & WIDTH ADJUSTMENT

[HIGH VOLTAGE ADJUSTMENT]

1. Tune the receiver to circular pattern.
2. Set brightness and contrast controls to maximum.
3. Connect digital V-meter to both terminals of R224, and high voltage meter to CRT anode.
4. Confirm high voltage to be 25.0 ± 1 KV at beam current 1.1mA, and less than 28.0 KV at 0 beam current.

[H-WIDTH ADJUSTMENT]

5. If H-width is too wide or narrow, connect or disconnect a lead wire J213.
6. Reconfirm high voltage.

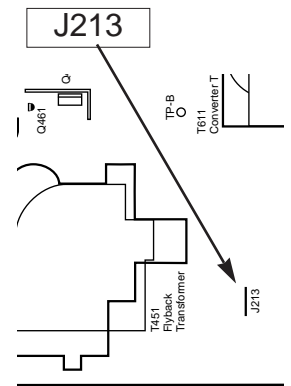

H-CENTRE ADJUSTMENT

1. Tune the receiver to circular pattern.
2. Adjust H-centre by using VR361.

V-CENTRE ADJUSTMENT

1. Tune the receiver to circular pattern.
2. Adjust V-centre by using SW501.

V-SIZE ADJUSTMENT

1. Tune the receiver to circular pattern.
2. Adjust V-size by using VR501.

FOCUS ADJUSTMENT

By using FOCUS VR, adjust focus control for good scanning lines.

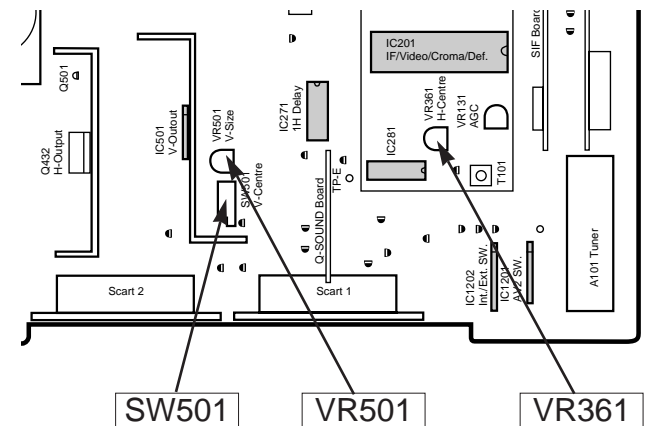

CIRCUIT ALIGNMENT

VIF alignment

SETTING		Adjustment	Waveform
DC 15.5V AGC voltage (4.3-4.5V) Output probe Input probe Marker frequency Sweep ATT 0dB=176mVrms/75	C644 + IC201-pin48 IC201-pin45 (Side b) IC201-pin7 38.9MHz 20dB	By using T141, adjust "P" to be maximum amplitude.	

SIF alignment

SETTING		Adjustment	Waveform
DC 12V AGC voltage(5V DC) Output probe Input probe Sweep ATT Marker Frequency Tool-A	IC3801-pin9 IC3801-pin13 IC3801-pin5 (Side b) IC3801-pin17 10dB 38.9MHz IC3801-pin6 and ground	1. By using T3801, adjust the VCO oscillation to be "P".	



Tool-A

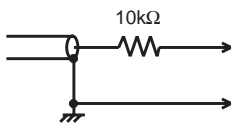

Input probe

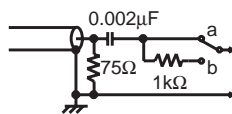

Output probe

SIF BOARD

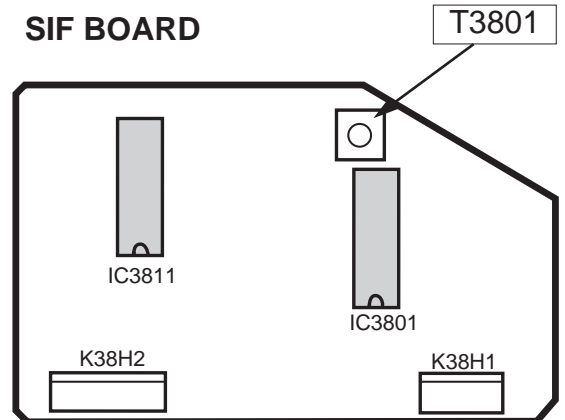

INITIALIZATION (Important Notice)

When you replace a memory IC (IC802), it is necessary to initialise the IC as following step.

A. Initialization

Press and hold the (→*←) **normalization button** on the remote control handset and press the (P▲) **programme + button** on the TV set.

The IC will be initialised automatically to set the following data.

User control data

Colour : Centre
Brightness : Centre
Contrast : Maximum
Sharpness : Centre
Text. Bright : Centre
Bass : Centre
Treble : Centre
Balance : Centre
Volume : Step 12

B. Service Mode

1. To enter the service mode, press and hold the (F□) **Function button** on the remote control handset and press the (P▲) **programme + button** on the TV set.

The following OSD appears on the screen.

ADJUST	DATA
System	+000
SCREEN	VOL
CPU MK2	1.0

2. Select desired service item by using the (F□) **Function button** on the remote control handset.
3. Change data by using the (◀+) **Level +** or (▶-) **- button**.
4. To return to TV mode press the (□▽) **Recall button** on the remote control handset.

Service mode description

SCREEN: For screen adjustment
To make one horizontal scanning line.

SPECIAL FUNCTION

This TV set allows you to set up the following special functions.

■ Maximum volume setting and prohibition of presetting

ITEM-1

Sets the current volume as the maximum volume level and prohibition of presetting.

SET → 0	NO
SET → 1	YES

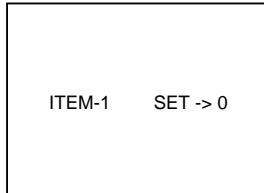







■ Start up programme position

ITEM-2

Presets the programme position when the set is switched on.

SET -> 0	Last programme position start
SET -> 1	Programme position "1" start
SET -> 2	Programme position "2" start
SET -> 3	Programme position "3" start
SET -> 4	Programme position "4" start
SET -> 5	Programme position "5" start
SET -> 6	Programme position "6" start
SET -> 7	Programme position "7" start
SET -> 8	Programme position "8" start
SET -> 9	"AV1" start

SETTING PROCEDURE

- 1 Press and hold the   button on the **Remote control handset** and then press the **P▲** button on the **TV set**.
- 2 To select the "Item" number, press the **F**  button on the **remote control handset**.
- 3 To select the "Set" number, press the  + or -  button repeatedly.
- 4 To return to the normal TV mode, press the   button.

- ✍ The setting conditions of all items can be confirmed.
- ✍ Special functions are not cancelled if the TV set is switched off or the mains disconnected.

SERVICE REF. NO. CE21DN4-C-01

CABINET PARTS LIST

Note: Parts order must contain Service Ref. No., Part No., and descriptions.

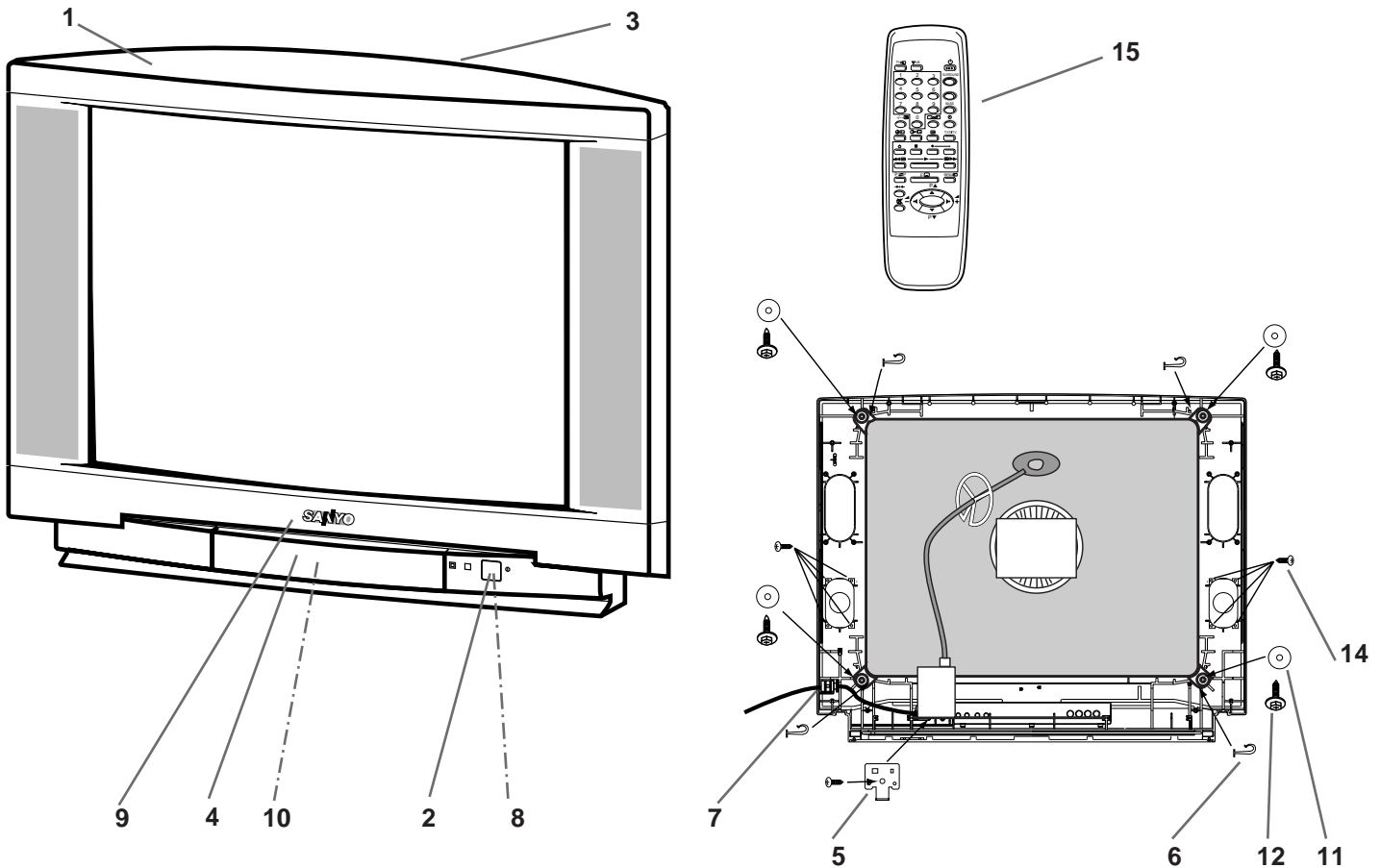

Ref. No.	Part No.	Description	Ref. No.	Part No.	Description
CABINET PARTS			ACCESSORIES		
1	610 278 0741	CABINET FRONT- F7KT	15	JXMCA	RC TRANSMITTER
2	610 276 5618	BUTTON POWER- F7WC		SKP10174	INST MANUAL - F7WW (1)
3	610 278 2349	CABINET BACK - F7KC		SKP10175	INST MANUAL - F7WW (2)
4	610 278 4923	D00R- F7WW		SKP10178	INST MANUAL - F7WW (3)
5	610 276 5656	DEC IND- F7WC		SKP20227	SHEM DIAG - F7KVV
6	610 265 4202	HOLDER DC GBR- F3SC		645 027 6927	BATTERY
7	610 253 2449	AC CORD HOLDER- U- D4VA			
8	610 261 3032	SPRING- E7GC			
9	645 030 7355	BADGE, SANYO*53. 5X12 GRAY			
10	645 019 2449	LATCH PUSH, 7. 9X6. 9BK			
11	610 224 5721	CRT CUSHION- B3MY- UK			
12	412 009 3003	SPECIAL SCREW			
13	411 076 1301	SCR TPG BRZ 4X14			
14	411 076 1004	SCR TPG BRZ 4X12			

CHASSIS ELECTRICAL PARTS LIST

Product safety should be considered when a component replacement is made in any area of a receiver. Components indicated by a Δ mark in this parts list and the circuit diagram show components whose value have special significance to product safety. It is particularly recommended that only parts specified on the following parts list be used for components replacement pointed out by the Δ mark.

Note: Parts order must contain Service Ref. No., Part No., and descriptions.

Ref. No.	Part No.	Description	Ref. No.	Part No.	Description
<p>Read description in the Capacitor and Resistor as follows:</p> <p>CAPACITOR CERAMIC 100P K 50V</p> <p>Rated Voltage</p> <p>Tolerance Symbols: Less than 10PF A: Not specified B: ± 0.1PF C: ± 0.25PF D: ± 0.5PF F: ± 1PF G: ± 2PF R: ± 0.25-0PF S: ± 0-0.25PF E: +0-1PF More than 10PF A: Not specified B: $\pm 0.1\%$ C: $\pm 0.25\%$ D: $\pm 0.5\%$ F: $\pm 1\%$ G: $\pm 2\%$ H: $\pm 3\%$ J: $\pm 5\%$ K: $\pm 10\%$ L: $\pm 15\%$ M: $\pm 20\%$ N: $\pm 30\%$ P: +100-0% Q: +30-10% T: +50-10% U: +75-10% V: +20-10% W: +100-10% X: +40-20% Y: +150-10% Z: +80-20%</p> <p>Rated value: P=pico farad, U=Micro farad</p> <p>Material: CERAMICCeramic MT-PAPERMetallized Paper POLYESTERPolyester MT-POLYESTMetallized Polyester POLYPROPolypropylene MT-POLYPROMetallized Polypropylene COMPO FILMComposite film MT-COMPOMetallized Composite STYRENEStyrene TA-SOLIDTantalum Solid AL-SOLIDAluminium Solid ELECTElectrolytic NP-ELECTNon-polarised Electrolytic OS-SOLIDAluminium Solid with Organic Semiconductive Electrolytic DL-ELECTDouble Layered Electrolytic</p>			<p>Chassis construction CE21D4-C-01</p> <p>OUT OF CIRCUIT-013F7KVV (Page 12) 1AA0B10H03500 ASSY,PWB,CRT-MK2 F3SSY (Page 12-13) 1AA0B10H018X0 ASSY,PWB,MAIN F7KVV (Page 13-20) 1AA0B10H0330A ASSY,PWB,SIF F3SS (Page 20) 1AA0B10H0330B ASSY,PWB,AUDIO F3SS MK2 (Page 20)</p> <p>.....</p> <p>OUT OF CIRCUIT BOARD</p> <p>PICTURE TUBE Δ Q901 414 007 9001 CRT A51EBV13X09</p> <p>COIL Δ L901 645 002 5624 DEGAUSSING COIL 21INCH</p> <p>M SCELLANEOUS</p> <p>SP901 610 232 3986 SPEAKER 610 228 7202 SPEAKER SP902 610 232 3986 SPEAKER 610 228 7202 SPEAKER Δ W901 645 012 7632 EURO PLUG +2P HOUSE @ 2. 1 W902 610 024 2531 GROUNDING CONNECTOR</p> <p>ASSY,PWB,CRT F2RC 1AA0B10E24500</p> <p>TRANSISTOR</p> <p>Q701 405 041 6507 TR 2SC2621- D- RA 405 041 6705 TR 2SC2621- E- RA 405 066 9903 TR 2SC2688(1) - K 405 067 0008 TR 2SC2688(1) - L 405 067 0107 TR 2SC2688(1) - M Q711 405 041 6507 TR 2SC2621- D- RA 405 041 6705 TR 2SC2621- E- RA 405 066 9903 TR 2SC2688(1) - K 405 067 0008 TR 2SC2688(1) - L 405 067 0107 TR 2SC2688(1) - M Q721 405 041 6507 TR 2SC2621- D- RA 405 041 6705 TR 2SC2621- E- RA 405 066 9903 TR 2SC2688(1) - K 405 067 0008 TR 2SC2688(1) - L 405 067 0107 TR 2SC2688(1) - M Q740 406 007 1901 TR JC556A 406 007 1802 TR JC556B 405 004 4205 TR 2SA608- E- CTV- NP 405 004 4809 TR 2SA608- F- CTV- NP Q751 406 007 1901 TR JC556A 406 007 1802 TR JC556B 405 004 4205 TR 2SA608- E- CTV- NP 405 004 4809 TR 2SA608- F- CTV- NP</p> <p>CAPACITOR</p> <p>C701 403 073 2910 CERAMI C 390P K 50V C711 403 073 2910 CERAMI C 390P K 50V C721 403 073 2910 CERAMI C 390P K 50V</p>		
<p>RESISTOR CARBON 4.7K J A 1/4W</p> <p>Rated Wattage</p> <p>Performance Symbols: A: General B: Non flammable Z: Low noise Other: Temperature coefficient</p> <p>Tolerance Symbols: A: $\pm 0.05\%$ B: $\pm 0.1\%$ C: $\pm 0.25\%$ D: $\pm 0.5\%$ F: $\pm 1\%$ G: $\pm 2\%$ J: $\pm 5\%$ K: $\pm 10\%$ M: $\pm 20\%$ P: +5-15%</p> <p>Rated value, ohms: K: 1,000, M: 1,000,000</p> <p>Material: CARBONCarbon MT-FILMMetal Film OXIDE-MTOxide Metal Film SOLIDComposition MT-GLAZEMetal Glaze WIRE WOUNDWire Wound CERAMIC RES.....Ceramic FUSIBLE RESFusible</p>					

Ref. No.	Part No.	Description	Ref. No.	Part No.	Description
C731	403 077 2728	CERAMIC 1000P P 2K	Q1003	406 007 2106	TR JC546A
C735	403 055 8401	ELECT 22U M 250V		406 007 2007	TR JC546B
C751	403 248 1608	ELECT 47U M 16V		405 019 1909	TR 2SC536-E-NP
				405 019 2708	TR 2SC536-F-NP
				405 019 3804	TR 2SC536-G-NP
RESISTOR			Q1004	406 007 2106	TR JC546A
R701	401 026 3925	CARBON 330 JA 1/6W		406 007 2007	TR JC546B
R702	401 026 7022	CARBON 3K9 JA 1/6W		405 019 1909	TR 2SC536-E-NP
R703	401 025 4220	CARBON 1K8 JA 1/6W		405 019 2708	TR 2SC536-F-NP
Δ R704	401 065 4604	OXIDE-MF 12K JA 2W		405 019 3804	TR 2SC536-G-NP
R705	401 009 6622	CARBON 3.3K JA 1/2W		406 007 2106	TR JC546A
R711	401 026 3925	CARBON 330 JA 1/6W	Q1005	406 007 2007	TR JC546B
R712	401 026 7022	CARBON 3K9 JA 1/6W		405 019 1909	TR 2SC536-E-NP
R713	401 026 1020	CARBON 2K7 JA 1/6W		405 019 2708	TR 2SC536-F-NP
Δ R714	401 065 4604	OXIDE-MF 12K JA 2W		405 019 3804	TR 2SC536-G-NP
R715	401 009 6622	CARBON 3.3K JA 1/2W		406 007 2106	TR JC546A
R721	401 026 3925	CARBON 330 JA 1/6W	Q1041	406 007 2007	TR JC546B
R722	401 026 7022	CARBON 3K9 JA 1/6W		405 019 1909	TR 2SC536-E-NP
R723	401 025 4220	CARBON 1K8 JA 1/6W		405 019 2708	TR 2SC536-F-NP
Δ R724	401 065 4604	OXIDE-MF 12K JA 2W		405 019 3804	TR 2SC536-G-NP
R725	401 009 6622	CARBON 3.3K JA 1/2W		406 007 1901	TR JC556A
R727	401 026 9620	CARBON 470 JA 1/6W	Q1042	406 007 1802	TR JC556B
R741	401 026 9927	CARBON 4K7 JA 1/6W		405 004 4205	TR 2SA608-E-CTV-NP
R742	401 026 4328	CARBON 3K3 JA 1/6W		405 004 4809	TR 2SA608-F-CTV-NP
R744	401 026 0627	CARBON 270 JA 1/6W		405 028 7909	TR 2SA608-G-CTV-NP
R752	401 024 7430	CARBON 10K JA 1/6W		406 007 2106	TR JC546A
R753	401 024 7430	CARBON 10K JA 1/6W	Q1043	406 007 2007	TR JC546B
				405 019 1909	TR 2SC536-E-NP
				405 019 2708	TR 2SC536-F-NP
				405 019 3804	TR 2SC536-G-NP
VARIABLE RESISTOR			Q1201	406 007 2106	TR JC546A
VR701	645 003 5722	VR, SEMI, 4.7K N		406 007 2007	TR JC546B
VR702	645 003 5647	VR, SEMI, 1K N		405 019 1909	TR 2SC536-E-NP
VR711	645 003 5722	VR, SEMI, 4.7K N		405 019 2708	TR 2SC536-F-NP
VR712	645 003 5647	VR, SEMI, 1K N		405 019 3804	TR 2SC536-G-NP
VR721	645 003 5722	VR, SEMI, 4.7K N		406 007 2106	TR JC546A
COIL			Q1202	406 007 2007	TR JC546B
L701	645 007 9856	PEAKING COIL 220UH K		405 019 1909	TR 2SC536-E-NP
L711	645 007 9856	PEAKING COIL 220UH K		405 019 2708	TR 2SC536-F-NP
L721	645 007 9856	PEAKING COIL 220UH K		405 019 3804	TR 2SC536-G-NP
DIODE			Q1203	406 007 2106	TR JC546A
D701	407 012 4416	DIODE 1SS133-T-77		406 007 2007	TR JC546B
D711	407 012 4416	DIODE 1SS133-T-77		405 019 1909	TR 2SC536-E-NP
D721	407 012 4416	DIODE 1SS133-T-77		405 019 2708	TR 2SC536-F-NP
D751	407 012 4416	DIODE 1SS133-T-77		405 019 3804	TR 2SC536-G-NP
MISCELLANEOUS			Q121	406 007 2106	TR JC546A
K7M	645 008 4058	TERMINAL PLUG		406 007 2007	TR JC546B
K7P	645 008 7288	HOUSING PLUG 5P		405 019 1909	TR 2SC536-E-NP
K7Q	645 008 7264	HOUSING PLUG 3P		405 019 2708	TR 2SC536-F-NP
Δ K701	645 031 7699	CRT SKT. HPS-014103		405 019 3804	TR 2SC536-G-NP
ASSY,PWB,MAIN F7KVV		1AA0B10H018X0	Q151	406 007 1901	TR JC556A
				406 007 1802	TR JC556B
				405 004 4205	TR 2SA608-E-CTV-NP
				405 004 4809	TR 2SA608-F-CTV-NP
				405 028 7909	TR 2SA608-G-CTV-NP
TRANSISTOR			Q152	406 007 2106	TR JC546A
Q001	406 007 2106	TR JC546A		406 007 2007	TR JC546B
	406 007 2007	TR JC546B		405 019 1909	TR 2SC536-E-NP
	405 019 1909	TR 2SC536-E-NP		405 019 2708	TR 2SC536-F-NP
	405 019 2708	TR 2SC536-F-NP		405 019 3804	TR 2SC536-G-NP
	405 019 3804	TR 2SC536-G-NP		406 007 1901	TR JC556A
Q1001	406 007 1901	TR JC556A	Q153	406 007 1802	TR JC556B
	406 007 1802	TR JC556B		405 004 4205	TR 2SA608-E-CTV-NP
	405 004 4205	TR 2SA608-E-CTV-NP		405 004 4809	TR 2SA608-F-CTV-NP
	405 004 4809	TR 2SA608-F-CTV-NP		405 004 809	TR 2SA608-G-CTV-NP
	405 028 7909	TR 2SA608-G-CTV-NP		405 028 7909	TR 2SA608-G-CTV-NP
Q1002	406 007 2106	TR JC546A	Q154	406 007 1901	TR JC556A
	406 007 2007	TR JC546B		406 007 1802	TR JC556B
	405 019 1909	TR 2SC536-E-NP		405 004 4205	TR 2SA608-E-CTV-NP
	405 019 2708	TR 2SC536-F-NP		405 004 4809	TR 2SA608-F-CTV-NP
	405 019 3804	TR 2SC536-G-NP			

Ref. No.	Part No.	Description	Ref. No.	Part No.	Description
Q171	405 028 7909	TR 2SA608- G- CTV- NP	Q873	406 007 2007	TR JC546B
	406 007 2106	TR JC546A		405 019 1909	TR 2SC536- E- NP
	406 007 2007	TR JC546B		405 019 2708	TR 2SC536- F- NP
	405 019 1909	TR 2SC536- E- NP		405 019 3804	TR 2SC536- G- NP
	405 019 2708	TR 2SC536- F- NP		406 007 2106	TR JC546A
Q2001	405 019 3804	TR 2SC536- G- NP	Q874	406 007 2007	TR JC546B
	406 007 2106	TR JC546A		405 019 1909	TR 2SC536- E- NP
	406 007 2007	TR JC546B		405 019 2708	TR 2SC536- F- NP
	405 019 1909	TR 2SC536- E- NP		405 019 3804	TR 2SC536- G- NP
	405 019 2708	TR 2SC536- F- NP		406 007 2106	TR JC546A
Q201	405 019 3804	TR 2SC536- G- NP		406 007 2007	TR JC546B
	406 007 2106	TR JC546A		405 019 1909	TR 2SC536- E- NP
	406 007 2007	TR JC546B		405 019 2708	TR 2SC536- F- NP
	405 019 1909	TR 2SC536- E- NP		405 019 3804	TR 2SC536- G- NP
	405 019 2708	TR 2SC536- F- NP			
Q202	405 019 3804	TR 2SC536- G- NP	INTEGRATED CIRCUIT		
	406 007 2106	TR JC546A	IC001	409 301 4906	IC TDA7263M
	406 007 2007	TR JC546B	IC1201	409 018 7603	IC LA7016
	405 019 1909	TR 2SC536- E- NP	IC1202	409 120 3401	IC LA7221
	405 019 2708	TR 2SC536- F- NP	IC201	409 380 8703	IC TDA8361/N5
Q431	405 011 1808	TR 2SC1627- 0	IC271	409 291 0605	IC TDA4661/V2
	405 011 1907	TR 2SC1627- Y		409 322 0505	IC TDA4662/V1
	405 013 6801	TR 2SC2274- E	IC501	409 183 5008	IC LA7832
	405 013 7006	TR 2SC2274- F	IC651	409 143 3402	IC AN78M12 LB
	406 015 2402	TR BU2508DX(ON5109)		409 365 2900	IC BA178M12T
Q432	405 022 6809	TR 2SD1651- CTV- YB	IC652	409 269 1207	IC L78M12CV
	406 007 2106	TR JC546A		409 366 1803	IC MC78M12CT
	406 007 2007	TR JC546B		409 362 7403	IC AN78M08 LB
	405 019 1909	TR 2SC536- E- NP		409 365 2801	IC BA178M08T
	405 019 2708	TR 2SC536- F- NP		409 285 5203	IC L78M08- RA
Q501	405 019 3804	TR 2SC536- G- NP	IC653	409 269 1108	IC L78M08CV
	406 007 1901	TR JC556A		409 366 1704	IC MC78M08CT
	406 007 1802	TR JC556B		409 241 5407	IC BA178M05T
	405 004 4205	TR 2SA608- E- CTV- NP		409 265 4806	IC L78M05CV
	405 004 4809	TR 2SA608- F- CTV- NP		409 172 1509	IC MC78M05CT
Q611	405 028 7909	TR 2SA608- G- CTV- NP	IC654	409 367 2809	IC BA178M09T
	405 058 0208	TR 2SC3807- R- CTV- YA	IC801	410 342 3308	IC SAA5296ZP/094
	405 018 9203	TR 2SC3895- T- CTV- YB	IC802	409 247 7702	IC ST24C02AB1
	406 007 2106	TR JC546A		409 281 8307	IC 24C02A/P
	406 007 2007	TR JC546B	IC810	409 333 3700	IC 24LC02B/P
Q612	405 058 0208	TR 2SC3807- R- CTV- YA	CAPACITOR		
	405 018 9203	TR 2SC3895- T- CTV- YB	C001A	403 068 0409	CERAMI C 0. 1U Z 25V
	406 007 2106	TR JC546A		403 070 2606	CERAMI C 0. 1U Z 50V
	406 007 2007	TR JC546B	C002	403 070 9803	CERAMI C 0. 015U K 50V
	405 019 1909	TR 2SC536- E- NP	C003A	403 068 0409	CERAMI C 0. 1U Z 25V
Q681	405 019 2708	TR 2SC536- F- NP		403 070 2606	CERAMI C 0. 1U Z 50V
	405 019 3804	TR 2SC536- G- NP	C004	403 070 9803	CERAMI C 0. 015U K 50V
	405 059 9804	TR 2SD1913- Q- RA	C005	403 046 3507	ELECT 33U M 25V
	405 059 9903	TR 2SD1913- R- RA	C006	403 046 3507	ELECT 33U M 25V
	405 060 0005	TR 2SD1913- S- RA	C007	403 270 3403	MT- POLYEST 0. 22U K 63V
Q682	406 007 1901	TR JC556A		403 237 7901	MT- COMPO 0. 22U J 50V
	406 007 1802	TR JC556B	C008	403 270 3403	MT- POLYEST 0. 22U K 63V
	405 004 4205	TR 2SA608- E- CTV- NP		403 237 7901	MT- COMPO 0. 22U J 50V
	405 004 4809	TR 2SA608- F- CTV- NP	C009	403 270 3403	MT- POLYEST 0. 22U K 63V
	405 028 7909	TR 2SA608- G- CTV- NP		403 237 7901	MT- COMPO 0. 22U J 50V
Q801	405 118 4207	TR PH2369	C010	403 270 3403	MT- POLYEST 0. 22U K 63V
	406 007 2106	TR JC546A		403 237 7901	MT- COMPO 0. 22U J 50V
	406 007 2007	TR JC546B	C011	403 042 4805	ELECT 1000U M 16V
	405 019 1909	TR 2SC536- E- NP	C012	403 042 4805	ELECT 1000U M 16V
	405 019 2708	TR 2SC536- F- NP	C013	403 069 9500	CERAMI C 0. 01U Z 50V
Q835	405 019 3804	TR 2SC536- G- NP	C014	403 069 9500	CERAMI C 0. 01U Z 50V
	406 007 1901	TR JC556A	C015	403 047 3100	ELECT 47U M 25V
	406 007 1802	TR JC556B	C016	403 085 4008	NP- ELECT 10U M 16V
	405 004 4205	TR 2SA608- E- CTV- NP	C017	403 085 4008	NP- ELECT 10U M 16V
	405 004 4809	TR 2SA608- F- CTV- NP	C020	403 069 0507	CERAMI C 1000P K 50V
Q861	405 028 7909	TR 2SA608- G- CTV- NP	C021	403 052 8503	ELECT 1000U M 35V
	405 118 4207	TR PH2369	C023	403 069 9500	CERAMI C 0. 01U Z 50V
	406 007 2106	TR JC546A	C024	403 069 9500	CERAMI C 0. 01U Z 50V
	406 007 2007	TR JC546B	C1001	403 069 1702	CERAMI C 1000P K 50V
	405 019 1909	TR 2SC536- E- NP			
Q871	405 019 2708	TR 2SC536- F- NP			
	405 019 3804	TR 2SC536- G- NP			
	406 007 2106	TR JC546A			
	406 007 2007	TR JC546B			
	405 019 1909	TR 2SC536- E- NP			
Q872	405 019 2708	TR 2SC536- F- NP			
	405 019 3804	TR 2SC536- G- NP			
	406 007 2106	TR JC546A			

Ref. No.	Part No.	Description	Ref. No.	Part No.	Description
C1002	403 041 8804	ELECT 10U M 16V		403 070 2606	CERAMI C 0. 1U Z 50V
C1003	403 009 5708	CERAMI C 100P J 50V	C2002	403 068 0409	CERAMI C 0. 1U Z 25V
C1004	403 130 3109	CERAMI C 0. 047U K 50V		403 070 2606	CERAMI C 0. 1U Z 50V
C1005	403 069 1702	CERAMI C 1000P K 50V	C2003	403 068 0409	CERAMI C 0. 1U Z 25V
C1006	403 041 8804	ELECT 10U M 16V		403 070 2606	CERAMI C 0. 1U Z 50V
C1007	403 009 5708	CERAMI C 100P J 50V	C201	403 014 3409	CERAMI C 18P J 50V
C1008	403 130 3109	CERAMI C 0. 047U K 50V	C202	403 270 2901	MT- POLYEST 0. 1U K 63V
C1009	403 041 8804	ELECT 10U M 16V		403 237 8007	MT- COMPO 0. 1U J 50V
C101	403 194 4609	ELECT 470U M 16V	C203	403 073 9107	CERAMI C 4700P K 50V
C102	403 043 9106	ELECT 47U M 16V	C204	403 068 0409	CERAMI C 0. 1U Z 25V
C1021	403 069 1702	CERAMI C 1000P K 50V		403 070 2606	CERAMI C 0. 1U Z 50V
C1022	403 041 8804	ELECT 10U M 16V	C205	403 068 0409	CERAMI C 0. 1U Z 25V
C1023	403 009 5708	CERAMI C 100P J 50V		403 070 2606	CERAMI C 0. 1U Z 50V
C1024	403 041 9405	ELECT 10U M 16V	C206	403 068 0409	CERAMI C 0. 1U Z 25V
C1025	403 069 1702	CERAMI C 1000P K 50V		403 070 2606	CERAMI C 0. 1U Z 50V
C1026	403 041 8804	ELECT 10U M 16V	C207	403 068 0409	CERAMI C 0. 1U Z 25V
C1027	403 009 5708	CERAMI C 100P J 50V		403 070 2606	CERAMI C 0. 1U Z 50V
C1028	403 041 9405	ELECT 10U M 16V	C208	403 068 0409	CERAMI C 0. 1U Z 25V
C1029	403 041 8804	ELECT 10U M 16V		403 070 2606	CERAMI C 0. 1U Z 50V
C103A	403 069 1712	CERAMI C 1000P K 50V	C209	403 069 1702	CERAMI C 1000P K 50V
C1031	403 033 4500	CERAMI C 82P J 50V	C212	403 049 9803	ELECT 2. 2U M 50V
C104B	403 043 9106	ELECT 47U M 16V	C215	403 270 3908	MT- POLYEST 0. 47U K 63V
C1041	403 041 8804	ELECT 10U M 16V		403 256 0808	MT- COMPO 0. 47U J 50V
C106	403 049 0008	ELECT 1U M 50V	C222	404 045 6605	NP- ELECT 2. 2U M 50V
C106A	403 069 9500	CERAMI C 0. 01U Z 50V	C226	403 138 1602	ELECT 1U M 100V
C107A	403 069 1702	CERAMI C 1000P K 50V	C231	403 068 0409	CERAMI C 0. 1U Z 25V
C107B	403 069 9510	CERAMI C CHIP 0. 01Z 50V		403 070 2606	CERAMI C 0. 1U Z 50V
C108	403 027 1211	CERAMI C 5P J 50V	C232	403 033 4500	CERAMI C 82P J 50V
C109	403 027 1211	CERAMI C 5P J 50V	C233	403 068 0409	CERAMI C 0. 1U Z 25V
C110	403 033 4510	CERAMI C 82P J 50V		403 070 2606	CERAMI C 0. 1U Z 50V
C1101	403 041 8804	ELECT 10U M 16V	C234	403 033 4500	CERAMI C 82P J 50V
C1103	403 069 1702	CERAMI C 1000P K 50V	C235	403 008 7406	CERAMI C 10P D 50V
C1104	403 041 8804	ELECT 10U M 16V	C271	403 069 1702	CERAMI C 1000P K 50V
C1106	403 069 1702	CERAMI C 1000P K 50V	C272	403 069 1702	CERAMI C 1000P K 50V
C1107	403 041 8804	ELECT 10U M 16V	C273	403 069 9500	CERAMI C 0. 01U Z 50V
C1108	403 033 4500	CERAMI C 82P J 50V	C274	403 041 8804	ELECT 10U M 16V
C1109	403 008 7406	CERAMI C 10P D 50V	C351	403 270 2901	MT- POLYEST 0. 1U K 63V
C114	401 037 5004	MT- GLAZE 0. 000 ZA 1/10W		403 237 8007	MT- COMPO 0. 1U J 50V
C117	401 037 5004	MT- GLAZE 0. 000 ZA 1/10W	C352	403 270 3809	MT- POLYEST 0. 047U K 63V
C1200	403 069 9500	CERAMI C 0. 01U Z 50V		403 225 2703	MT- COMPO 0. 047U J 50V
C1201	403 041 8804	ELECT 10U M 16V	C353	403 073 9107	CERAMI C 4700P K 50V
C1202	403 041 8804	ELECT 10U M 16V	C354	403 049 0008	ELECT 1U M 50V
C1203	403 069 8305	CERAMI C 0. 01U Z 50V	C361	403 072 5605	CERAMI C 2700P K 50V
C121	403 068 0409	CERAMI C 0. 1U Z 25V	C362	403 069 9500	CERAMI C 0. 01U Z 50V
	403 070 2606	CERAMI C 0. 1U Z 50V	C363	403 042 2405	ELECT 100U M 16V
C131	401 037 5004	MT- GLAZE 0. 000 ZA 1/10W	△ C421	404 046 8400	MT- POLYPRO 8200P J 1. 5K
C132	403 069 1702	CERAMI C 1000P K 50V	△ C425	403 324 2406	CERAMI C 330P K 3K
C133	403 069 9500	CERAMI C 0. 01U Z 50V		403 287 3601	CERAMI C 330P K 3K
C134	403 049 9803	ELECT 2. 2U M 50V		403 232 3007	CERAMI C 330P K 3K
C135	403 068 0409	CERAMI C 0. 1U Z 25V	C430	403 075 9709	CERAMI C 1800P K 500V
	403 070 2606	CERAMI C 0. 1U Z 50V	C432	403 075 7101	CERAMI C 1000P K 500V
C136	403 194 4609	ELECT 470U M 16V	C433	403 076 3102	CERAMI C 3900P K 500V
C137	403 068 0409	CERAMI C 0. 1U Z 25V	C434	403 229 1207	ELECT 47U M 35V
	403 070 2606	CERAMI C 0. 1U Z 50V	C437	403 066 6106	MT- POLYEST 0. 47U J 250V
C138	403 069 9500	CERAMI C 0. 01U Z 50V	C438	403 059 3808	POLYESTER 2200P K 50V
C141	403 028 4409	CERAMI C 56P J 50V		403 179 2606	POLYESTER 2200P K 50V
C142	403 068 0409	CERAMI C 0. 1U Z 25V	△ C441	403 216 7601	POLYPRO 0. 36U J 200V
	403 070 2606	CERAMI C 0. 1U Z 50V	C445	403 049 4204	ELECT 10U M 50V
C143	403 027 1201	CERAMI C 5P C 50V	C481	403 076 1405	CERAMI C 2700P K 500V
C146	403 010 8507	CERAMI C 12P J 50V	C482	403 159 7409	MT- POLYEST 0. 1U K 250V
C151	403 024 2102	CERAMI C 39P J 50V	C501	403 054 1502	ELECT 470U M 35V
C162	403 068 0409	CERAMI C 0. 1U Z 25V	C502	403 053 2104	ELECT 220U M 35V
	403 070 2606	CERAMI C 0. 1U Z 50V	C503	403 024 2102	CERAMI C 39P J 50V
C171	403 270 2901	MT- POLYEST 0. 1U K 63V	C504	403 069 9500	CERAMI C 0. 01U Z 50V
	403 237 8007	MT- COMPO 0. 1U J 50V	C505	403 075 7101	CERAMI C 1000P K 500V
C1901	403 069 1702	CERAMI C 1000P K 50V	C506	403 183 7901	MT- POLYEST 0. 1U K 100V
C200	403 068 0409	CERAMI C 0. 1U Z 25V		403 256 4806	MT- COMPO 0. 1U J 100V
	403 070 2606	CERAMI C 0. 1U Z 50V	C511	403 188 1201	MT- POLYEST 0. 15U K 100V
C2001	403 068 0409	CERAMI C 0. 1U Z 25V		403 313 7603	MT- COMPO 0. 15U J 100V

Ref. No.	Part No.	Description	Ref. No.	Part No.	Description
C512	403 148 0404	ELECT 1000U M 25V	C879	403 068 0409	CERAMI C 0. 1U Z 25V
C513	403 049 4204	ELECT 10U M 50V		403 070 2606	CERAMI C 0. 1U Z 50V
C514	403 049 4204	ELECT 10U M 50V	C881	403 069 9500	CERAMI C 0. 01U Z 50V
C600	403 076 4000	CERAMI C 4700P K 500V	C882	403 041 8804	ELECT 10U M 16V
△ C601	404 056 1408	MT- POLYEST 0. 1U M 250V	C883	403 018 0503	CERAMI C 22P J 50V
	404 074 6508	MT- COMPO 0. 1U K 250V	C884	403 018 0503	CERAMI C 22P J 50V
	404 077 6307	MT- POLYPRO 0. 1U M 250V	C892	403 069 9500	CERAMI C 0. 01U Z 50V
△ C602	404 056 1408	MT- POLYEST 0. 1U M 250V			
	404 074 6508	MT- COMPO 0. 1U K 250V			
	404 077 6307	MT- POLYPRO 0. 1U M 250V			
C603	403 312 8205	CERAMI C 1000P K 1K	RESISTOR		
	403 076 7100	CERAMI C 1000P M 1K	R001	401 037 5400	MT- GLAZE 1K JA 1/10W
C604	403 312 8205	CERAMI C 1000P K 1K	R002	401 037 9200	MT- GLAZE 1. 8K JA 1/10W
	403 076 7100	CERAMI C 1000P M 1K	R003	401 037 5400	MT- GLAZE 1K JA 1/10W
C605	403 312 8205	CERAMI C 1000P K 1K	R004	401 037 9200	MT- GLAZE 1. 8K JA 1/10W
	403 076 7100	CERAMI C 1000P M 1K	R005	401 019 9600	CARBON 47 JA 1/4W
C606	403 312 8205	CERAMI C 1000P K 1K	R006	401 014 4105	CARBON 1. 5K JA 1/4W
	403 076 7100	CERAMI C 1000P M 1K	R007	401 019 9600	CARBON 47 JA 1/4W
C607	404 047 1707	ELECT 220U M 400V	R008	401 014 4105	CARBON 1. 5K JA 1/4W
	404 069 5905	ELECT 220U M 400V	R009	401 010 1504	CARBON 4. 7 JA 1/2W
C613	403 061 8303	POLYESTER 4700P K 50V	R010	401 010 1504	CARBON 4. 7 JA 1/2W
	403 179 1104	POLYESTER 4700P K 50V	R011	401 007 7601	CARBON 150 JA 1/2W
C614	403 270 2901	MT- POLYEST 0. 1U K 63V	R012	401 007 7601	CARBON 150 JA 1/2W
	403 237 8007	MT- COMPO 0. 1U J 50V	R013	401 037 6704	MT- GLAZE 1. 2K JA 1/10W
C615	403 058 2604	POLYESTER 0. 015U J 50V	R014	401 025 7409	CARBON 220 JA 1/6W
	403 179 3207	POLYESTER 0. 015U J 50V	R015	401 037 5400	MT- GLAZE 1K JA 1/10W
C616	403 247 6604	CERAMI C 680P K 2K	R016	401 038 6505	MT- GLAZE 47K JA 1/10W
	403 232 2109	CERAMI C 680P K 2K	R017	401 037 5608	MT- GLAZE 10K JA 1/10W
C617	403 179 1718	POLYESTER 0. 033U J 50V	R100	401 037 5004	MT- GLAZE 0. 000 ZA 1/10W
△ C631	404 060 6505	CERAMI C 2200P M 400V	R1001	401 038 7601	MT- GLAZE 560 JA 1/10W
	404 071 4200	CERAMI C 2200P M 400V	R1002	401 038 0701	MT- GLAZE 2. 2K JA 1/10W
	404 060 6604	CERAMI C 2200P M 400V	R1003	401 038 7601	MT- GLAZE 560 JA 1/10W
△ C632	404 044 2806	CERAMI C 470P K 400V	R1004	401 038 0701	MT- GLAZE 2. 2K JA 1/10W
	404 071 4606	CERAMI C 470P K 400V	R1005	401 027 6608	CARBON 75 JA 1/6W
	404 060 6901	CERAMI C 470P M 400V	R1006	401 038 5300	MT- GLAZE 39K JA 1/10W
C640	403 069 8305	CERAMI C 0. 01U Z 50V	R1007	401 038 3702	MT- GLAZE 33K JA 1/10W
C641	403 247 6505	CERAMI C 680P K 1K	R1008	401 027 6608	CARBON 75 JA 1/6W
	403 262 4401	CERAMI C 680P K 1K	R1009	401 027 6608	CARBON 75 JA 1/6W
C642A	404 042 4505	ELECT 220U M 160V	R101	401 038 6218	MT- GLAZE 47 JA 1/10W
C643	403 148 2002	ELECT 470U M 35V	R1010	401 027 6608	CARBON 75 JA 1/6W
C644	403 148 0701	ELECT 2200U M 25V	R1011	401 037 5202	MT- GLAZE 100 JA 1/10W
C645	403 158 1309	ELECT 2200U M 35V	R1012	401 027 6608	CARBON 75 JA 1/6W
C651	403 148 0305	ELECT 470U M 16V	R1013	401 024 6700	CARBON 100 JA 1/6W
C652	403 069 9500	CERAMI C 0. 01U Z 50V	R1014	401 027 6608	CARBON 75 JA 1/6W
C653	403 043 9106	ELECT 47U M 16V	R1015	401 038 6406	MT- GLAZE 4. 7K JA 1/10W
C655	403 126 4400	ELECT 100U M 10V	R1016	401 019 1000	CARBON 390 JA 1/4W
C661	403 051 0607	ELECT 4. 7U M 50V	R1017	401 024 7400	CARBON 10K JA 1/6W
C681	403 190 4702	ELECT 1000U M 25V	R1018	401 038 3504	MT- GLAZE 330 JA 1/10W
C682	403 069 9500	CERAMI C 0. 01U Z 50V	R1021	401 038 7601	MT- GLAZE 560 JA 1/10W
C683	403 147 9606	ELECT 1000U M 10V	R1022	401 038 0701	MT- GLAZE 2. 2K JA 1/10W
C684	403 050 6600	ELECT 3. 3U M 50V	R1023	401 038 7601	MT- GLAZE 560 JA 1/10W
C802	403 270 2901	MT- POLYEST 0. 1U K 63V	R1024	401 038 0701	MT- GLAZE 2. 2K JA 1/10W
	403 237 8007	MT- COMPO 0. 1U J 50V	R1025	401 038 5300	MT- GLAZE 39K JA 1/10W
C812	403 049 0008	ELECT 1U M 50V	R1026	401 038 3702	MT- GLAZE 33K JA 1/10W
C814	403 049 0008	ELECT 1U M 50V	R1027	401 027 6608	CARBON 75 JA 1/6W
C816	403 046 9905	ELECT 4. 7U M 25V	R1028	401 027 6608	CARBON 75 JA 1/6W
C818	403 046 9905	ELECT 4. 7U M 25V	R1029	401 026 0607	CARBON 270 JA 1/6W
C841	403 069 9500	CERAMI C 0. 01U Z 50V	R1031	401 038 0602	MT- GLAZE 220 JA 1/10W
C860	403 022 8205	CERAMI C 33P J 50V	R1032	401 038 0602	MT- GLAZE 220 JA 1/10W
C861	403 138 5600	POLYESTER 5600P J 50V	R1033	401 038 0602	MT- GLAZE 220 JA 1/10W
	403 179 0800	POLYESTER 5600P J 50V	R1041	401 038 2200	MT- GLAZE 27K JA 1/10W
C871	403 068 0409	CERAMI C 0. 1U Z 25V	R1042	401 037 5608	MT- GLAZE 10K JA 1/10W
	403 070 2606	CERAMI C 0. 1U Z 50V	R1043	401 039 0304	MT- GLAZE 820 JA 1/10W
C872	403 043 9106	ELECT 47U M 16V	R1044	401 039 0304	MT- GLAZE 820 JA 1/10W
C873	403 018 0503	CERAMI C 22P J 50V	R1045	401 037 5400	MT- GLAZE 1K JA 1/10W
C874	403 018 0503	CERAMI C 22P J 50V	R1046	401 038 0701	MT- GLAZE 2. 2K JA 1/10W
C875	403 068 0409	CERAMI C 0. 1U Z 25V	R1047	401 037 6704	MT- GLAZE 1. 2K JA 1/10W
	403 070 2606	CERAMI C 0. 1U Z 50V	R1051	401 037 8104	MT- GLAZE 150K JA 1/10W
C878	403 073 9107	CERAMI C 4700P K 50V	R1052	401 037 5707	MT- GLAZE 100K JA 1/10W
			R1053	401 037 6704	MT- GLAZE 1. 2K JA 1/10W
			R1054	401 037 8104	MT- GLAZE 150K JA 1/10W

Ref. No.	Part No.	Description	Ref. No.	Part No.	Description
R1055	401 037 5707	MT- GLAZE 100K JA 1/10W	R208	401 037 5202	MT- GLAZE 100 JA 1/10W
R1056	401 037 6704	MT- GLAZE 1. 2K JA 1/10W	R212	401 026 1000	CARBON 2. 7K JA 1/6W
R108	401 037 5004	MT- GLAZE 0. 000 ZA 1/10W	R213	401 038 7700	MT- GLAZE 5. 6K JA 1/10W
R110	401 037 5004	MT- GLAZE 0. 000 ZA 1/10W	R214	401 037 5202	MT- GLAZE 100 JA 1/10W
R1101	401 027 6608	CARBON 75 JA 1/6W	R215	401 038 3702	MT- GLAZE 33K JA 1/10W
R1102	401 038 2002	MT- GLAZE 270 JA 1/10W	R216	401 025 8208	CARBON 22K JA 1/6W
R1103	401 038 0701	MT- GLAZE 2. 2K JA 1/10W	R217	401 025 8208	CARBON 22K JA 1/6W
R1104	401 038 0701	MT- GLAZE 2. 2K JA 1/10W	R218	401 038 7809	MT- GLAZE 56K JA 1/10W
R1105	401 037 5707	MT- GLAZE 100K JA 1/10W	R223	401 015 4708	CARBON 180K JA 1/4W
R1106	401 037 5707	MT- GLAZE 100K JA 1/10W	R224	401 024 7004	CARBON 1K JA 1/6W
R1111	401 037 5608	MT- GLAZE 10K JA 1/10W	R226	401 026 7408	CARBON 39K JA 1/6W
R1200	401 022 1905	CARBON 680 JA 1/4W	R227	401 024 7400	CARBON 10K JA 1/6W
R1201	401 038 6505	MT- GLAZE 47K JA 1/10W	R231	401 038 2002	MT- GLAZE 270 JA 1/10W
R1202	401 038 6505	MT- GLAZE 47K JA 1/10W	R232	401 038 2002	MT- GLAZE 270 JA 1/10W
R1203	401 037 5608	MT- GLAZE 10K JA 1/10W	R271	401 024 6700	CARBON 100 JA 1/6W
R1204	401 038 2200	MT- GLAZE 27K JA 1/10W	R272	401 024 9008	CARBON 120 JA 1/6W
R1205	401 038 2200	MT- GLAZE 27K JA 1/10W	R351	401 037 5202	MT- GLAZE 100 JA 1/10W
R1208	401 038 0800	MT- GLAZE 22K JA 1/10W	R352	401 012 9300	CARBON 1M JA 1/4W
R1209	401 024 7400	CARBON 10K JA 1/6W	R353	401 038 0909	MT- GLAZE 220K JA 1/10W
R121	401 027 0309	CARBON 47K JA 1/6W	R356	401 037 5202	MT- GLAZE 100 JA 1/10W
R131	401 038 0909	MT- GLAZE 220K JA 1/10W	R357	401 037 8005	MT- GLAZE 15K JA 1/10W
R132	401 038 0909	MT- GLAZE 220K JA 1/10W	R361	401 038 5409	MT- GLAZE 390K JA 1/10W
R133	401 037 9101	MT- GLAZE 180 JA 1/10W	R363	401 038 0800	MT- GLAZE 22K JA 1/10W
R134	401 039 0413	MT- GLAZE 8. 2K JA 1/10W	R364	401 037 5202	MT- GLAZE 100 JA 1/10W
R135	401 038 0810	MT- GLAZE 22K JA 1/10W	R365	401 038 6406	MT- GLAZE 4. 7K JA 1/10W
R137	401 037 5202	MT- GLAZE 100 JA 1/10W	R431	401 038 3504	MT- GLAZE 330 JA 1/10W
R138	401 038 7700	MT- GLAZE 5. 6K JA 1/10W	R432	401 038 3504	MT- GLAZE 330 JA 1/10W
R141	401 038 9209	MT- GLAZE 6. 8K JA 1/10W	R433	401 010 3102	CARBON 470 JA 1/2W
R150	401 024 7004	CARBON 1K JA 1/6W	△ R434	401 067 9201	OXI DE- MT 390 JA 2W
R151	401 022 1905	CARBON 680 JA 1/4W	△ R435	402 069 8704	WI RE WOUND 8. 2 KA 7W
R152	401 025 3807	CARBON 180 JA 1/6W		402 076 0609	WI RE WOUND 8. 2 KA 7W
R153	401 037 5400	MT- GLAZE 1K JA 1/10W	R436	401 021 3009	CARBON 5. 6K JA 1/4W
R154	401 038 2101	MT- GLAZE 2. 7K JA 1/10W	△ R441	401 058 3706	OXI DE- MT 1K JA 1W
R155	401 037 5400	MT- GLAZE 1K JA 1/10W	R447	401 026 9907	CARBON 4. 7K JA 1/6W
R156	401 037 5400	MT- GLAZE 1K JA 1/10W	R448	401 009 5803	CARBON 330 JA 1/2W
R157	401 039 0908	MT- GLAZE 910 JA 1/10W	△ R451	401 064 5701	OXI DE- MT 1. 8 JA 2W
R158	401 037 5400	MT- GLAZE 1K JA 1/10W	R481	401 025 4903	CARBON 180K JA 1/6W
R159	401 022 1905	CARBON 680 JA 1/4W	R482	401 027 2600	CARBON 5. 6K JA 1/6W
R163	401 038 6505	MT- GLAZE 47K JA 1/10W	R501	401 026 9907	CARBON 4. 7K JA 1/6W
R171	401 038 6307	MT- GLAZE 470 JA 1/10W	△ R502	402 051 8705	FUSI BLE RES 4. 7 J- 1/2W
R172	401 025 7409	CARBON 220 JA 1/6W	R504	401 027 3003	CARBON 56K JA 1/6W
R173	401 025 7409	CARBON 220 JA 1/6W	R505	401 024 7400	CARBON 10K JA 1/6W
R1901	401 037 8005	MT- GLAZE 15K JA 1/10W	R506	401 025 1605	CARBON 1. 5K JA 1/6W
R1901A	401 037 5004	MT- GLAZE 0. 000 ZA 1/10W	R507	401 025 3807	CARBON 180 JA 1/6W
R1902	401 039 0403	MT- GLAZE 8. 2K JA 1/10W	R508	401 025 7805	CARBON 2. 2K JA 1/6W
R1902A	401 037 5004	MT- GLAZE 0. 000 ZA 1/10W	△ R509	401 057 9105	OXI DE- MT 1. 2 JA 1W
R1903	401 038 6406	MT- GLAZE 4. 7K JA 1/10W	△ R511	401 060 7402	OXI DE- MT 270 JA 1W
R1903A	401 037 5004	MT- GLAZE 0. 000 ZA 1/10W	△ R513	401 059 3903	OXI DE- MT 1. 5K JA 1W
R1904	401 038 2101	MT- GLAZE 2. 7K JA 1/10W	△ R602	402 067 7709	WI RE WOUND 3. 9 KA 7W
R1905	401 038 0701	MT- GLAZE 2. 2K JA 1/10W		402 072 4403	WI RE WOUND 3. 9 KA 7W
R1906	401 037 5004	MT- GLAZE 0. 000 ZA 1/10W	R611	401 027 2600	CARBON 5. 6K JA 1/6W
R1907	401 037 5608	MT- GLAZE 10K JA 1/10W	R615	401 025 8208	CARBON 22K JA 1/6W
R1908	401 038 3504	MT- GLAZE 330 JA 1/10W	R617	401 024 9305	CARBON 1. 2K JA 1/6W
R1909	401 037 7909	MT- GLAZE 1. 5K JA 1/10W	R619	401 016 1508	CARBON 22 JA 1/4W
R1911	401 038 6307	MT- GLAZE 470 JA 1/10W	R620	401 007 5805	CARBON 120K JA 1/2W
R1921	401 037 6605	MT- GLAZE 120 JA 1/10W	R621	401 007 5805	CARBON 120K JA 1/2W
R1922	401 038 5003	MT- GLAZE 390 JA 1/10W	R622	401 014 5201	CARBON 15K JA 1/4W
R1924	401 027 5502	CARBON 6. 8K JA 1/6W	R623	401 025 7805	CARBON 2. 2K JA 1/6W
R2001	401 038 2200	MT- GLAZE 27K JA 1/10W	△ R624	401 068 6902	OXI DE- MT 56 JA 2W
R2002	401 037 5608	MT- GLAZE 10K JA 1/10W	△ R625	401 067 8204	OXI DE- MT 39 JA 2W
R2004	401 037 7800	MT- GLAZE 150 JA 1/10W	R626	401 016 3304	CARBON 2. 2K GA 1/4W
R2005	401 024 9701	CARBON 12K JA 1/6W	△ R631	402 000 8305	SOLI D 5. 6M KA 1/2W
R201	401 039 0403	MT- GLAZE 8. 2K JA 1/10W	△ R632	402 000 8305	SOLI D 5. 6M KA 1/2W
R202	401 037 5707	MT- GLAZE 100K JA 1/10W	R641	401 012 8105	CARBON 100K JA 1/4W
R203	401 024 6700	CARBON 100 JA 1/6W	R642	401 026 9907	CARBON 4. 7K JA 1/6W
R204	401 024 6700	CARBON 100 JA 1/6W	R643	401 014 6109	CARBON 150K JA 1/4W
R205	401 024 6700	CARBON 100 JA 1/6W	R644	401 010 4307	CARBON 47K JA 1/2W
R206	401 037 5202	MT- GLAZE 100 JA 1/10W	R645	401 025 8208	CARBON 22K JA 1/6W
R207	401 037 5202	MT- GLAZE 100 JA 1/10W	△ R646	402 067 3305	WI RE WOUND 4. 7 KA 5W

Ref. No.	Part No.	Description	Ref. No.	Part No.	Description
	402 075 5704	WIRE WOUND 4. 7 KA 5W	R885	401 038 5102	MT- GLAZE 3. 9K JA 1/10W
△ R652	401 065 1801	OXI DE- MF 12 JA 2W	R886	401 037 7800	MT- GLAZE 150 JA 1/10W
△ R653	401 067 8204	OXI DE- MF 39 JA 2W	R887	401 038 5102	MT- GLAZE 3. 9K JA 1/10W
△ R655	401 065 5809	OXI DE- MF 15 JA 2W	R888	401 037 5202	MT- GLAZE 100 JA 1/10W
△ R661	401 068 4700	OXI DE- MF 4. 7K JA 2W	R889	401 037 5202	MT- GLAZE 100 JA 1/10W
△ R662	401 068 0207	OXI DE- MF 3. 9K JA 2W	R891	401 038 6406	MT- GLAZE 4. 7K JA 1/10W
R681	401 008 1608	CARBON 1. 8K JA 1/2W	R892	401 038 6406	MT- GLAZE 4. 7K JA 1/10W
R682	401 069 1708	OXI DE- MF 68 JA 2W	R893	401 037 5400	MT- GLAZE 1K JA 1/10W
R684	401 027 8602	CARBON 8. 2K JA 1/6W	R894	401 037 5400	MT- GLAZE 1K JA 1/10W
R685	401 025 8208	CARBON 22K JA 1/6W	R895	401 037 6704	MT- GLAZE 1. 2K JA 1/10W
R800	401 025 7805	CARBON 2. 2K JA 1/6W	R897	401 024 7004	CARBON 1K JA 1/6W
R801	401 037 5004	MT- GLAZE 0. 000 ZA 1/10W	R898	401 024 7004	CARBON 1K JA 1/6W
R802	401 038 0701	MT- GLAZE 2. 2K JA 1/10W			
R803	401 037 9408	MT- GLAZE 180K JA 1/10W			
R804	401 024 7400	CARBON 10K JA 1/6W	VARIABLE RESISTOR		
R806	401 024 7400	CARBON 10K JA 1/6W	VR131	645 006 5422	VR, SEMI, 10K N
R807	401 024 7400	CARBON 10K JA 1/6W		645 003 5531	VR, SEMI, 10K N
R808	401 019 1901	CARBON 3. 9K JA 1/4W		610 239 7567	VR B- 10K
R811	401 025 7805	CARBON 2. 2K JA 1/6W	VR361	645 006 5422	VR, SEMI, 10K N
R812	401 038 5102	MT- GLAZE 3. 9K JA 1/10W		645 003 5531	VR, SEMI, 10K N
R813	401 026 4605	CARBON 33K JA 1/6W		610 239 7567	VR B- 10K
R815	401 024 6700	CARBON 100 JA 1/6W	VR501	645 006 5408	VR, SEMI, 100 N
R816	401 038 9209	MT- GLAZE 6. 8K JA 1/10W		645 006 5231	VR, SEMI, 100 N
R817	401 025 7805	CARBON 2. 2K JA 1/6W	VR641	610 232 7908	VR, SEMI, 100 N
R817A	401 037 5004	MT- GLAZE 0. 000 ZA 1/10W		645 006 5514	VR, SEMI, 2. 2K N
R818	401 038 9308	MT- GLAZE 68K JA 1/10W		645 003 5579	VR, SEMI, 2. 2K N
R819	401 025 7805	CARBON 2. 2K JA 1/6W		610 239 7581	VR B- 2K
R820	401 037 5608	MT- GLAZE 10K JA 1/10W	TRANSFORMER		
R821	401 038 0800	MT- GLAZE 22K JA 1/10W	T101	610 037 4508	S COIL 33R4M- 7K
R822	401 038 6505	MT- GLAZE 47K JA 1/10W	T141	610 037 4522	S COIL
R823	401 024 9305	CARBON 1. 2K JA 1/6W	T431	610 000 1053	DRIVE TRANS
R824	401 038 0701	MT- GLAZE 2. 2K JA 1/10W		610 000 1060	DRIVE TRANS
R825	401 038 3603	MT- GLAZE 3. 3K JA 1/10W	△ T451	645 035 5295	TRANS, FLYBACK
R831	401 037 5608	MT- GLAZE 10K JA 1/10W	△ T611	645 015 7646	TRANS, POWER, PULSE
R838	401 037 8005	MT- GLAZE 15K JA 1/10W		645 018 9425	TRANS, POWER, PULSE
R839	401 026 4605	CARBON 33K JA 1/6W	△ T681	610 033 3758	POWER TRANS
R840	401 026 9600	CARBON 470 JA 1/6W		610 240 4722	POWER TRANS
R841	401 038 0800	MT- GLAZE 22K JA 1/10W	COIL		
R842	401 026 9907	CARBON 4. 7K JA 1/6W	L001	645 008 5635	INDUCTOR, 12U K
R843	401 037 5608	MT- GLAZE 10K JA 1/10W	L002	645 008 5635	INDUCTOR, 12U K
R844	401 037 9210	MT- GLAZE 1. 8K JA 1/10W	L003	645 002 1787	CORE, PIPE
R845	401 037 5608	MT- GLAZE 10K JA 1/10W	L1002	645 002 1787	CORE, PIPE
R846	401 038 6406	MT- GLAZE 4. 7K JA 1/10W	L1003	645 001 4567	INDUCTOR, 10U K
R847	401 037 5608	MT- GLAZE 10K JA 1/10W	L1004	645 001 4567	INDUCTOR, 10U K
R848	401 038 6406	MT- GLAZE 4. 7K JA 1/10W	L1005	645 001 4567	INDUCTOR, 10U K
R851	401 037 5400	MT- GLAZE 1K JA 1/10W	L1006	645 001 4567	INDUCTOR, 10U K
R852	401 037 5400	MT- GLAZE 1K JA 1/10W	L101	645 001 4567	INDUCTOR, 10U K
R853	401 038 0800	MT- GLAZE 22K JA 1/10W	L102	645 008 2863	INDUCTOR, 4. 7U K
R861	401 038 2101	MT- GLAZE 2. 7K JA 1/10W	L1022	645 002 1787	CORE, PIPE
R862	401 038 0800	MT- GLAZE 22K JA 1/10W	L1023	645 001 4567	INDUCTOR, 10U K
R863	401 038 0800	MT- GLAZE 22K JA 1/10W	L1024	645 001 4567	INDUCTOR, 10U K
R864	401 039 0304	MT- GLAZE 820 JA 1/10W	L1025	645 001 4567	INDUCTOR, 10U K
R865	401 038 0701	MT- GLAZE 2. 2K JA 1/10W	L1026	645 001 4567	INDUCTOR, 10U K
R866	401 038 0701	MT- GLAZE 2. 2K JA 1/10W	L1027	645 008 2863	INDUCTOR, 4. 7U K
R867	401 038 0701	MT- GLAZE 2. 2K JA 1/10W	L1101	645 001 4567	INDUCTOR, 10U K
R868	401 037 6704	MT- GLAZE 1. 2K JA 1/10W	L1102	645 001 4567	INDUCTOR, 10U K
R869	401 038 2200	MT- GLAZE 27K JA 1/10W	L1103	645 008 2863	INDUCTOR, 4. 7U K
R870A	401 038 0800	MT- GLAZE 22K JA 1/10W	L141	645 001 4567	INDUCTOR, 10U K
R871	401 038 6406	MT- GLAZE 4. 7K JA 1/10W	L151	645 008 2924	INDUCTOR, 8. 2U K
R872	401 038 3702	MT- GLAZE 33K JA 1/10W	L152	645 003 9782	INDUCTOR, 22U K
R873	401 038 6406	MT- GLAZE 4. 7K JA 1/10W	L201	645 001 4567	INDUCTOR, 10U K
R874	401 037 5608	MT- GLAZE 10K JA 1/10W	L202	645 001 4567	INDUCTOR, 10U K
R875	401 038 7700	MT- GLAZE 5. 6K JA 1/10W	L203	645 001 4567	INDUCTOR, 10U K
R876	401 037 5608	MT- GLAZE 10K JA 1/10W	L231	645 008 2863	INDUCTOR, 4. 7U K
R877	401 039 0403	MT- GLAZE 8. 2K JA 1/10W	L232	645 008 2863	INDUCTOR, 4. 7U K
R878	401 037 7909	MT- GLAZE 1. 5K JA 1/10W	L432	645 002 1787	CORE, PIPE
R879	401 037 5608	MT- GLAZE 10K JA 1/10W	L441A	610 000 0605	LI NEARITY COIL
R880	401 038 6505	MT- GLAZE 47K JA 1/10W		610 210 8071	LI NEARITY COIL
R884	401 037 7800	MT- GLAZE 150 JA 1/10W			

Ref. No.	Part No.	Description	Ref. No.	Part No.	Description
L442	610 000 0278	COIL		407 057 9701	ZENER DIODE RD9. 1EB2
	610 205 1117	COIL		407 163 9909	ZENER DIODE UZ- 9. 1BCA
L501	645 008 5642	INDUCTOR, 3. 3U K		407 162 2703	ZENER DIODE UZ- 9. 1BCB
Δ L601	645 012 3337	LINE FILTER	D432	407 005 7308	DIODE EM01Z
L607	610 237 1000	PIPE CORE	D442	407 013 1008	DIODE 1S1553
L608	610 237 1000	PIPE CORE		407 013 4306	DIODE 1S2076A
L641	645 002 1787	CORE, PIPE		407 013 6508	DIODE 1S2471
L642	645 002 1787	CORE, PIPE	D445	407 012 4406	DIODE 1SS133
L643	645 002 1787	CORE, PIPE		407 012 5809	DIODE 1SS176
L871	645 008 0203	INDUCTOR, 5. 6U K	D446	407 151 9003	ZENER DIODE UZ- 7. 5BCC
L881	645 001 4697	INDUCTOR, 1. 5U M		407 151 9102	ZENER DIODE UZ- 8. 2BCA
			D481	407 007 7405	DIODE EU1
			D482	407 012 4406	DIODE 1SS133
				407 012 5809	DIODE 1SS176
DIODE			D501	407 005 7308	DIODE EM01Z
D1005	407 063 8309	ZENER DIODE MTZJ11C		408 009 9008	DIODE BYD33D
	407 158 3400	ZENER DIODE UZ- 11BSC		407 118 2207	ZENER DIODE 1Z75
D1007	407 063 8309	ZENER DIODE MTZJ11C	D502	407 006 6300	DIODE ERC05- 10B
	407 158 3400	ZENER DIODE UZ- 11BSC	D603	407 009 6901	DIODE RMI1C
D1008	407 063 8309	ZENER DIODE MTZJ11C		407 006 6300	DIODE ERC05- 10B
	407 158 3400	ZENER DIODE UZ- 11BSC	D604	407 009 6901	DIODE RMI1C
D1010	407 063 8309	ZENER DIODE MTZJ11C		407 006 6300	DIODE ERC05- 10B
	407 158 3400	ZENER DIODE UZ- 11BSC	D605	407 006 6300	DIODE ERC05- 10B
D1011	407 063 8309	ZENER DIODE MTZJ11C		407 009 6901	DIODE RMI1C
	407 158 3400	ZENER DIODE UZ- 11BSC	D606	407 006 6300	DIODE ERC05- 10B
D1021	407 063 8309	ZENER DIODE MTZJ11C		407 009 6901	DIODE RMI1C
	407 158 3400	ZENER DIODE UZ- 11BSC	D614	407 013 1008	DIODE 1S1553
D1022	407 063 8309	ZENER DIODE MTZJ11C		407 013 4306	DIODE 1S2076A
	407 158 3400	ZENER DIODE UZ- 11BSC		407 013 6508	DIODE 1S2471
D1023	407 063 8309	ZENER DIODE MTZJ11C	Δ D615	407 105 8700	PHOTO COUPLE PC113B
	407 158 3400	ZENER DIODE UZ- 11BSC		408 009 8407	PHOTO COUPLE CNY17F- 30PT6
D1024	407 063 8309	ZENER DIODE MTZJ11C	D616	407 013 1008	DIODE 1S1553
	407 158 3400	ZENER DIODE UZ- 11BSC		407 013 4306	DIODE 1S2076A
D1026	407 063 8309	ZENER DIODE MTZJ11C		407 013 6508	DIODE 1S2471
	407 158 3400	ZENER DIODE UZ- 11BSC	D617	407 007 6606	DIODE ES1
D1027	407 063 8309	ZENER DIODE MTZJ11C		407 007 6903	DIODE ES1Z
	407 158 3400	ZENER DIODE UZ- 11BSC		408 009 9008	DIODE BYD33D
D1101	407 063 8309	ZENER DIODE MTZJ11C	D618	407 013 1008	DIODE 1S1553
	407 158 3400	ZENER DIODE UZ- 11BSC		407 013 4306	DIODE 1S2076A
D1201	407 053 6803	ZENER DIODE MTZ5. 6C		407 013 6508	DIODE 1S2471
	407 057 0104	ZENER DIODE RD5. 6EB3	D619	407 053 3000	ZENER DIODE MTZ11C
	407 151 8501	ZENER DIODE UZ- 5. 6BCC		407 054 1807	ZENER DIODE RD11EB3
D135	407 063 8309	ZENER DIODE MTZJ11C	D641	407 007 7702	DIODE EU2A
	407 158 3400	ZENER DIODE UZ- 11BSC	D642	407 007 7603	DIODE EU2
D1901- 1	610 269 4710	HOLDER LED A- G2CA		407 007 7801	DIODE EU2Z
D1901A	407 116 6504	LED SLP- 181B- 51	Δ D643	407 166 2303	DIODE ERC91- 02L
D1903	407 063 8309	ZENER DIODE MTZJ11C	Δ D644	407 166 2303	DIODE ERC91- 02L
	407 158 3400	ZENER DIODE UZ- 11BSC	D645	407 053 7206	ZENER DIODE MTZ6. 2C
D1905	407 012 4406	DIODE 1SS133		407 053 7503	ZENER DIODE MTZ6. 8A
	407 012 5809	DIODE 1SS176		407 057 2801	ZENER DIODE RD6. 2EB3
D201	407 063 8309	ZENER DIODE MTZJ11C		407 057 4003	ZENER DIODE RD6. 8EB1
	407 158 3400	ZENER DIODE UZ- 11BSC	D647	407 012 4406	DIODE 1SS133
D202	407 063 8309	ZENER DIODE MTZJ11C		407 012 5809	DIODE 1SS176
	407 158 3400	ZENER DIODE UZ- 11BSC	D651	407 005 7308	DIODE EM01Z
D203	407 063 8309	ZENER DIODE MTZJ11C	D654	407 012 4406	DIODE 1SS133
	407 158 3400	ZENER DIODE UZ- 11BSC		407 012 5809	DIODE 1SS176
D210	407 012 4406	DIODE 1SS133	D661	409 013 0104	IC HZT33
	407 012 5809	DIODE 1SS176		409 026 8005	IC L5630
D221	407 012 4406	DIODE 1SS133		409 057 5103	IC UPC574J
	407 012 5809	DIODE 1SS176	D681	407 005 7308	DIODE EM01Z
D222	407 013 1008	DIODE 1S1553	D682	407 053 6803	ZENER DIODE MTZ5. 6C
	407 013 4306	DIODE 1S2076A		407 057 0104	ZENER DIODE RD5. 6EB3
	407 013 6508	DIODE 1S2471		407 151 8501	ZENER DIODE UZ- 5. 6BCC
D271	407 053 6407	ZENER DIODE MTZ5. 1C	D683	407 005 7308	DIODE EM01Z
	407 056 8200	ZENER DIODE RD5. 1EB3	D684	408 007 8607	DIODE 1N4148
	407 163 8209	ZENER DIODE UZ- 5. 1BCC		407 013 1206	DIODE 1S1555
D361	407 063 8309	ZENER DIODE MTZJ11C	D685	407 012 4406	DIODE 1SS133
	407 158 3400	ZENER DIODE UZ- 11BSC		407 012 5809	DIODE 1SS176
D431	407 053 8708	ZENER DIODE MTZ9. 1A	D831	407 013 1008	DIODE 1S1553
	407 053 8807	ZENER DIODE MTZ9. 1B		407 013 4306	DIODE 1S2076A
	407 057 9602	ZENER DIODE RD9. 1EB1			

Ref. No.	Part No.	Description	Ref. No.	Part No.	Description
D861	407 013 6508	DIODE 1S2471	R3816	401 038 3504	MT-GLAZE 330 JA 1/10W
	407 012 4406	DIODE 1SS133	R3817	401 039 0304	MT-GLAZE 820 JA 1/10W
	407 012 5809	DIODE 1SS176	R3818	401 037 6704	MT-GLAZE 1.2K JA 1/10W
D871	407 012 4406	DIODE 1SS133	TRANSFORMER		
	407 012 5809	DIODE 1SS176	T3801	610 037 4539	S COIL
D872	407 055 7907	ZENER DIODE RD3.6EL	MISCELLANEOUS		
MISCELLANEOUS			MISCELLANEOUS		
△	423 022 2102	FUSE 250V 4A	K38H1	645 027 0185	PLUG, 4P
F601A	645 000 5077	HOLDER, FUSE	K38H2	645 027 0185	PLUG, 4P
F601B	645 000 5077	HOLDER, FUSE	X3801	421 007 2109	SAW F TSB5392T
A101	645 023 4118	TUNER, U/V	ASSY,PWB,AUDIO F3SS MK2 1AA0B10H0330B		
A1901	645 007 1546	UNIT, REMOCON RECEIVER	TRANSISTOR		
K001	610 224 5806	RC PREAMP 409-1L	Q1252	405 014 4519	TR 2SC2412KT146/R
	645 005 5706	JACK, PHONE D3.6	Q1253	405 014 4519	TR 2SC2412KT146/R
K10B	645 006 4708	JACK, PHONE D3.6	Q3452	405 014 4519	TR 2SC2412KT146/R
	645 004 2911	PLUG, 5P	Q3453	405 014 4519	TR 2SC2412KT146/R
K1001	645 005 5867	SOCKET, RGB 21P	Q3501	405 014 4519	TR 2SC2412KT146/R
	610 234 3779	SOCKET 21P	Q3502	405 014 4519	TR 2SC2412KT146/R
K1001Z	610 261 2813	MOUNTING-BRKT F2WW	Q3503	405 014 4519	TR 2SC2412KT146/R
K1002	645 005 5867	SOCKET, RGB 21P	INTEGRATED CIRCUIT		
K1002Z	610 234 3779	SOCKET 21P	IC1251	409 009 2501	IC HD14052BP
	610 261 2813	MOUNTING-BRKT F2WW		409 120 7607	IC MN4052B
K1101	645 016 6433	JACK, RCA-3		409 051 2801	IC TC4052BP
△ PS601	408 003 6805	THERMISTOR 902P44E180MR14		409 059 2209	IC UPD4052BC
SW1901	408 015 1904	THERMISTOR PA3A5180B270	IC3451	409 445 1403	IC TDA9875A/V2
	610 011 4432	SWITCH, PUSH	IC3500	409 367 2809	IC BA178M09T
SW1902	610 011 4432	SWITCH, PUSH		409 377 5401	IC L78M09CV
SW1903	610 011 4432	SWITCH, PUSH		409 370 0007	IC MC78M09CT
SW1904	610 011 4432	SWITCH, PUSH	IC3501	409 398 9204	IC MM1369AD
SW501	610 011 2728	SWITCH, LEVER 1P-3T		409 405 6004	IC MM1369BD
△ SW601	645 017 0928	SWITCH, PUSH POWER 2P-2T	CAPACITOR		
X131	421 002 2609	SAW F TSF5315	C1251	403 248 1618	ELECT 47U M 16V
	421 003 3902	SAW F TSF5315U	C3452	403 314 5915	SMD CAP GRM40X5R474K16
X151	610 015 2854	TRAP, CERAMIC 5.5MHZ	C3453	403 026 2813	CERAMIC 47P J 50V
X152	610 015 3011	TRAP, CERAMIC 6.5MHZ	C3454	403 068 0419	CERAMIC 0.1U Z 25V
X201	645 025 2631	OSC, CRYSTAL 4.433619MHZ	C3455	401 037 5014	MT-GLAZE 0.000 ZA 1/10W
	645 018 9050	OSC, CRYSTAL 4.433619MHZ	C3458	403 026 2813	CERAMIC 47P J 50V
X871	610 249 5577	CRYSTAL OSCILLATOR	C3461	403 248 1410	ELECT 1U M 50V
	645 018 9593	OSC, CRYSTAL 12MHZ	C3462	401 037 5014	MT-GLAZE 0.000 ZA 1/10W
645 015 8339	OSC, CRYSTAL 12MHZ	C3468	403 248 1410	ELECT 1U M 50V	
ASSY,PWB,SIF F3SS 1AA0B10H0330A			C3469	403 248 1410	ELECT 1U M 50V
TRANSISTOR			C3473	403 279 4312	CERAMIC 0.33U K 16V
Q3811	405 014 4509	TR 2SC2412K T146 R	C3474	403 279 4312	CERAMIC 0.33U K 16V
	405 015 8704	TR 2SC2812-L6-TB	C3476	403 314 5915	SMD CAP GRM40X5R474K16
INTEGRATED CIRCUIT			C3477	403 248 1618	ELECT 47U M 16V
IC3801	409 310 8407	IC LA7577N	C3480	403 248 1618	ELECT 47U M 16V
CAPACITOR			C3481	403 248 1618	ELECT 47U M 16V
C3805	403 023 4404	CERAMIC 330P J 50V	C3482	403 069 9510	CERAMIC CHIP 0.01 Z 50V
C3806	403 069 9500	CERAMIC 0.01U Z 50V	C3483	403 069 9510	CERAMIC CHIP 0.01 Z 50V
C3807	403 069 9500	CERAMIC 0.01U Z 50V	C3484	403 248 1618	ELECT 47U M 16V
C3808	403 041 8804	ELECT 10U M 16V	C3485	403 069 9510	CERAMIC CHIP 0.01 Z 50V
C3809	403 069 9500	CERAMIC 0.01U Z 50V	C3486	403 248 1410	ELECT 1U M 50V
C3810	403 046 9905	ELECT 4.7U M 25V	C3487	403 248 1410	ELECT 1U M 50V
C3811	403 018 0503	CERAMIC 22P J 50V	C3490	403 009 5718	CERAMIC 100P J 50V
C3812	403 048 6308	ELECT 0.47U M 50V	C3492	403 069 5611	CERAMIC 0.01U K 50V
C3813	403 074 6600	CERAMIC 560P K 50V	C3493	403 069 5611	CERAMIC 0.01U K 50V
C3814	403 069 1702	CERAMIC 1000P K 50V	C3500	403 248 1618	ELECT 47U M 16V
C3815	403 069 9500	CERAMIC 0.01U Z 50V	C3501	403 049 4204	ELECT 10U M 50V
RESISTOR			C3502	403 075 0716	CERAMIC 6800P K 50V
R3811	401 038 7502	MT-GLAZE 56 JA 1/10W	C3503	403 010 1112	CERAMIC 100
R3812	401 037 5608	MT-GLAZE 10K JA 1/10W	C3504	403 192 5915	CERAMIC 0.1U K 25V
R3815	401 037 5400	MT-GLAZE 1K JA 1/10W	C3505	403 248 1618	ELECT 47U M 16V
			C3506	403 248 2813	ELECT 2.2U M 50V
			C3507	403 069 5611	CERAMIC 0.01U K 50V

Ref. No.	Part No.	Description	Ref. No.	Part No.	Description
C3508	403 069 5611	CERAMIC 0.01U K 50V	R3518	401 038 0711	MT-GLAZE 2.2K JA 1/10W
C3509	403 069 5611	CERAMIC 0.01U K 50V			
C3510	403 069 5611	CERAMIC 0.01U K 50V	COIL		
C3511	403 010 1112	CERAMIC 100	L3450	401 037 5014	MT-GLAZE 0.000 ZA 1/10W
C3512	403 192 5915	CERAMIC 0.1U K 25V	L3452	645 011 0252	INDUCTOR, 2.2U K
C3513	403 075 0716	CERAMIC 6800P K 50V	L3456	645 011 0252	INDUCTOR, 2.2U K
C3514	403 049 4204	ELECT 10U M 50V	L3457	645 011 0252	INDUCTOR, 2.2U K
C3515	403 248 2813	ELECT 2.2U M 50V	L3459	401 037 5014	MT-GLAZE 0.000 ZA 1/10W
C3516	403 049 4204	ELECT 10U M 50V			
C3517	403 269 5916	CERAMIC 0.22U K 16V	MISCELLANEOUS		
C3518	403 248 1618	ELECT 47U M 16V	J1251	401 037 5014	MT-GLAZE 0.000 ZA 1/10W
C3520	403 248 1618	ELECT 47U M 16V	J3459	401 037 5014	MT-GLAZE 0.000 ZA 1/10W
C3521	403 279 4312	CERAMIC 0.33U K 16V	J3463	401 037 5014	MT-GLAZE 0.000 ZA 1/10W
C3522	403 279 4312	CERAMIC 0.33U K 16V	J3465	401 037 5014	MT-GLAZE 0.000 ZA 1/10W
			J3469	401 037 5014	MT-GLAZE 0.000 ZA 1/10W
RESISTOR			J3474	401 037 5014	MT-GLAZE 0.000 ZA 1/10W
R1251	401 038 9318	MT-GLAZE 68K JA 1/10W	J3486	401 037 5014	MT-GLAZE 0.000 ZA 1/10W
R1252	401 038 9318	MT-GLAZE 68K JA 1/10W	J3489	401 037 5014	MT-GLAZE 0.000 ZA 1/10W
R1253	401 038 9318	MT-GLAZE 68K JA 1/10W	J3501	401 037 5014	MT-GLAZE 0.000 ZA 1/10W
R1254	401 038 9318	MT-GLAZE 68K JA 1/10W	K12B	645 008 7288	HOUSING PLUG 5P
R1255	401 038 9318	MT-GLAZE 68K JA 1/10W	K34A	645 027 0192	PLUG, 10P
R1256	401 038 9318	MT-GLAZE 68K JA 1/10W	K34B	645 027 0192	PLUG, 10P
R1257	401 038 9318	MT-GLAZE 68K JA 1/10W	K34C	645 027 0178	PLUG, 3P
R1258	401 038 9318	MT-GLAZE 68K JA 1/10W	X3451	645 024 7484	OSC, CRYSTAL 24.576MHZ
R1261	401 038 6317	MT-GLAZE 470 JA 1/10W			
R1262	401 038 0711	MT-GLAZE 2.2K JA 1/10W			
R1263	401 038 6317	MT-GLAZE 470 JA 1/10W			
R1264	401 038 0711	MT-GLAZE 2.2K JA 1/10W			
R3451	401 037 5212	MT-GLAZE 100 JA 1/10W			
R3452	401 037 5212	MT-GLAZE 100 JA 1/10W			
R3453	401 037 5618	MT-GLAZE 10K JA 1/10W			
R3454	401 037 5212	MT-GLAZE 100 JA 1/10W			
R3455	401 037 5618	MT-GLAZE 10K JA 1/10W			
R3456	401 037 5014	MT-GLAZE 0.000 ZA 1/10W			
R3459	401 037 5014	MT-GLAZE 0.000 ZA 1/10W			
R3462	401 037 5014	MT-GLAZE 0.000 ZA 1/10W			
R3464	401 037 5212	MT-GLAZE 100 JA 1/10W			
R3465	401 037 5618	MT-GLAZE 10K JA 1/10W			
R3466	401 037 5410	MT-GLAZE 1K JA 1/10W			
R3467	401 038 2111	MT-GLAZE 2.7K JA 1/10W			
R3468	401 037 5410	MT-GLAZE 1K JA 1/10W			
R3469	401 038 2111	MT-GLAZE 2.7K JA 1/10W			
R3471	401 038 2012	MT-GLAZE 270 JA 1/10W			
R3472	401 037 5014	MT-GLAZE 0.000 ZA 1/10W			
R3473	401 038 6317	MT-GLAZE 470 JA 1/10W			
R3474	401 038 0711	MT-GLAZE 2.2K JA 1/10W			
R3475	401 038 6317	MT-GLAZE 470 JA 1/10W			
R3476	401 038 0711	MT-GLAZE 2.2K JA 1/10W			
R3477	401 038 5310	MT-GLAZE 39K JA 1/10W			
R3478	401 038 5310	MT-GLAZE 39K JA 1/10W			
R3479	401 037 8015	MT-GLAZE 15K JA 1/10W			
R3480	401 037 8015	MT-GLAZE 15K JA 1/10W			
R3501	401 180 0416	MT-GLAZE 7.5K FA 1/10W			
R3502	401 037 5212	MT-GLAZE 100 JA 1/10W			
R3503	401 037 5410	MT-GLAZE 1K JA 1/10W			
R3504	401 037 5410	MT-GLAZE 1K JA 1/10W			
R3505	401 039 0512	MT-GLAZE 82K JA 1/10W			
R3506	401 037 9319	MT-GLAZE 18K JA 1/10W			
R3507	401 038 0711	MT-GLAZE 2.2K JA 1/10W			
R3508	401 037 5410	MT-GLAZE 1K JA 1/10W			
R3509	401 038 9219	MT-GLAZE 6.8K JA 1/10W			
R3510	401 038 6416	MT-GLAZE 4.7K JA 1/10W			
R3511	401 038 0919	MT-GLAZE 220K JA 1/10W			
R3512	401 038 7819	MT-GLAZE 56K JA 1/10W			
R3513	401 038 7819	MT-GLAZE 56K JA 1/10W			
R3514	401 038 5112	MT-GLAZE 3.9K JA 1/10W			
R3515	401 037 5410	MT-GLAZE 1K JA 1/10W			
R3516	401 038 0711	MT-GLAZE 2.2K JA 1/10W			
R3517	401 037 5410	MT-GLAZE 1K JA 1/10W			

All information in this manual is correct at the start of production. Sanyo reserves the right to modify components and procedures in order to comply with their continuous improvement policy.

Ref. No.	Part No.	Description	Ref. No.	Part No.	Description
----------	----------	-------------	----------	----------	-------------

Ref. No.	Part No.	Description	Ref. No.	Part No.	Description
----------	----------	-------------	----------	----------	-------------

